

# Maintenance and Service Instructions

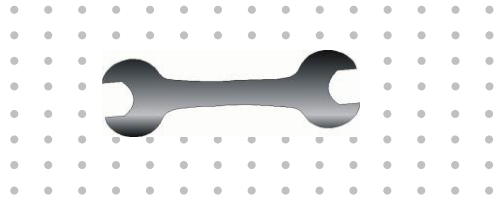

Testomat<sup>®</sup> 808 SiO<sub>2</sub>



# Contents

<b>Contents</b> .....	<b>2</b>
<b>Important safety information</b> .....	<b>3</b>
Qualification of the staff .....	3
Warning notices in these instructions .....	3
Further documents.....	4
<b>General instructions</b> .....	<b>4</b>
Important before carrying out repairs! .....	4
Prior to carrying out maintenance work .....	5
Permissible tools.....	6
<b>Carrying out maintenance</b> .....	<b>7</b>
Cleaning the measuring chamber .....	7
Removing the measuring chamber.....	7
Cleaning the measuring chamber.....	7
Cleaning the sight glasses.....	8
Installing and operating the measuring chamber.....	8
Cleaning the housing .....	8
Pump head maintenance intervals .....	9
Pump head maintenance message .....	9
Replacing the pump head.....	9
Bleeding the indicator lines .....	10
Disassemble the gear motor.....	11
Assemble the new gear motor .....	11
Synchronising a new optics board .....	12
<b>Service programs</b> .....	<b>13</b>
Test and adjustment program .....	13
Access to the Test and Adjustment program.....	13
Operating the T808 Monitor Program .....	13
Functions of keys in the test program.....	14
Serial interface settings: .....	16
Zeroing the first pump head operating hours counter.....	16
Updating the firmware .....	17
<b>Error correction</b> .....	<b>19</b>
Defective pump motor.....	20
<b>Spare parts list</b> .....	<b>21</b>
<b>Component positions</b> .....	<b>22</b>
Measuring chamber components .....	23
Location of fuses.....	24
<b>Testomat<sup>®</sup> 808 SiO2 checklist</b> .....	<b>25</b>



## Important safety information

- Please read the operating instructions and maintenance instructions carefully and completely prior to carrying out maintenance work at Testomat instruments.
- Observe the warning notices in these maintenance instructions and the operating instructions of the respective instrument.
- Always adhere to hazard warnings and safety tips when using reagents, chemicals and cleaning agents. Please adhere to the respective safety data sheet! Download the safety data sheets for the supplied reagents at <http://www.heyl.de>.

### Qualification of the staff

Maintenance work requires fundamental electrical and process engineering knowledge as well as knowledge of the respective technical terms. Assembly and commissioning should therefore only be carried out by a specialist or by an authorised individual supervised by a specialist.

A specialist is someone who due to his/her technical training, know-how and experience as well as knowledge of relevant regulations can assess assigned tasks, recognise potential hazards and ensure appropriate safety measures. A specialist should always adhere to the relevant technical regulations.

### Warning notices in these instructions

The warning notices in these instructions warn the user about potential dangers to individuals and property resulting from incorrect handling of the instrument. The warning notices are structured as follows:



#### SIGNAL WORD

#### Description of the type or source of danger

Description of the consequences resulting from non-observance

- Preventive measures. Always adhere to these preventive measures.



**DANGER**

“**DANGER**” indicates an immediate hazardous situation which, if not avoided, will result in death or serious injury.



**WARNING**

“**WARNING**” indicates a potentially hazardous situation which, if not avoided, could result in death or serious injury.

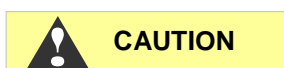

**CAUTION**

“**CAUTION**” indicates a potentially hazardous situation which, if not avoided, could result in minor or moderate injuries or property damage.



**NOTE**

“**NOTE**” indicates important information. If this information is not observed, it may result in an undesirable result or state.

## Further documents

Testomat instruments are plant components. Therefore, always observe the documentation of the plant manufacturer.

## General instructions

Regular maintenance is necessary to ensure trouble-free operation of the Testomat instrument. Regular visual inspections also increase operational reliability. Also refer to the notes in the operating instructions!

- Clean the measuring chamber at regular intervals (approx. every 3 months). All seals in the measuring chamber should be replaced after approx. 12 months. The inspection glasses must also be replaced at the same time. For maintenance, use our seal and inspection glass set (Article no. 270351).
- If the water is from a well or has high iron content, cleaning might be necessary more often.
- Only use a dry, lint-free cloth for cleaning (also refer to the chapter, [Cleaning the measuring chamber](#) on page 7).
- Wait at least 5 seconds before switching the instrument on and then off again at the main switch.
- Do not carry out any actions at the instrument which are not described in these instructions; failure to adhere to the instructions will negatively affect the warranty claims that you make thereafter.

### **Caution!**

Should you send your Testomat 808 in for maintenance, please make sure that the measuring chamber has been emptied.

## Important before carrying out repairs!

- The repair of a defective instrument – irrespective of the warranty period - is only possible after the instrument has been dismantled and returned to us with a description of the error.
- Furthermore, please inform us of the indicator type being used and the measured medium.
- Before you return the instrument for repair work, remove the bottle and ensure that the measuring chamber has been flushed out and is empty.
- Prior to dismantling, always write down a description of the error (failure effect). For this purpose, use our checklist which you will find on page 25 or download it from the download area at [www.heyl.de](http://www.heyl.de).

## Prior to carrying out maintenance work

Carry out a visual inspection of the instrument:

- Are the instrument door and the cover closed properly?
- Is the instrument heavily soiled?
- Is there air inside the dosing hoses?
- Are the hose connections of the dosing pump free of leaks?
- Has the use-by date of the indicator expired?

Always make sure that the sight-glass windows are clean before inserting a new indicator bottle.

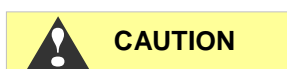

**CAUTION**

### Cleaning agents

- Never use organic solvents to clean the measuring chamber or other plastic parts!
- Use an acidic cleaning agent for cleaning.
- Please observe the safety regulations when handling cleaning agents!

### Overview of maintenance work to be executed

The maintenance intervals may vary depending on the water and pipeline quality.

Maintenance work	Quarterly	Semi-annually	Triquarterly	Annually	Page
Cleaning sight-glass windows	X				7
Cleaning measuring chamber / Measuring chamber holder	X				7
Cleaning the waste water line	X				
Electrical and hydraulic connections		X			
Renewing the seals (33777) and sight-glass windows (40170)				X	7
If used: Cleaning candle filter (37583)	X				
Replace double pump head (37801)	When pump head maintenance message flashes (E4)				9
Replace motor block (100494)	When pump head maintenance message flashes (E4)				11



## Permissible tools

Always use suitable tools for the described tasks. Refer to the table below for an overview of suitable tools for updating the firmware.

Type	Application	Art. no.
Software T808_SiO2_ServiceMonitor	Service program, e.g. to read and reset the meter readings	Download
Software FlashTool	Program for installing the new firmware	Download
New firmware	The latest firmware for Testomat® 808 SiO2	Download
Notebook	For transferring the firmware	-
Null modem cable	For connecting the PC and Testomat® 808 SiO2	31972
Adapter USB > Serial	An adapter for the null modem cable, for when the notebook has no available serial interface.	32286

### NOTE

#### Software and Firmware

- The software **FlashTool** for updating the firmware and the **T808\_SiO2\_ServiceMonitor** software is available for free download on our website at [www.hey1.de](http://www.hey1.de).
- New firmware for Testomat® 808 can be found on our website at [www.hey1.de](http://www.hey1.de)
- All tools listed above (not including the notebook) can also be found in our repair and service kits for the Testomat® 808 SiO2 (Article no. 270343).

## Carrying out maintenance

### Cleaning the measuring chamber

You must remove the measuring chamber for cleaning. Proceed as follows:

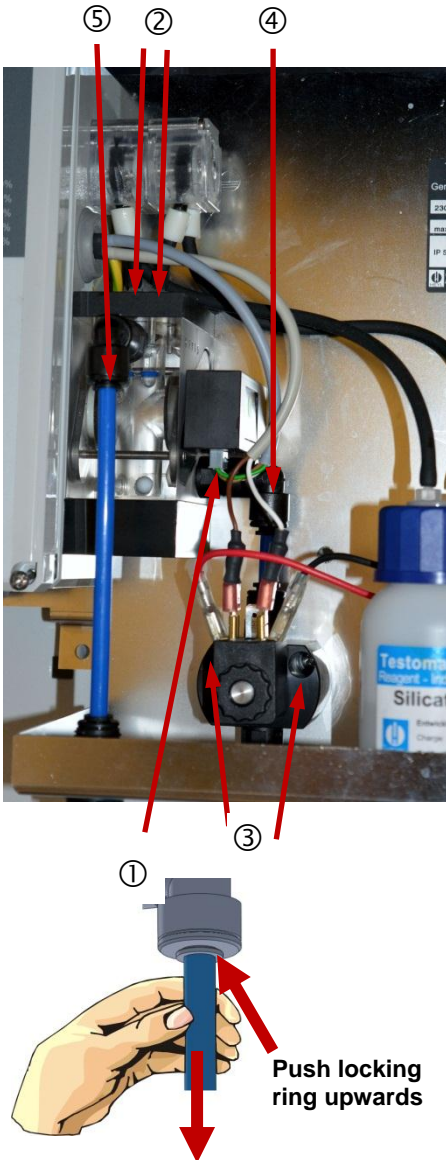

#### Removing the measuring chamber

- Disconnect the device from the power supply.
- Close the stop valve in the branch line to Testomat<sup>®</sup> 808 SiO<sub>2</sub>.
- Prior to disassembling the measuring chamber, disconnect the cable ① from the LED holder and loosen the pump hoses at the hose connectors ② of the measuring chamber.
- You can also remove the reagent bottle to facilitate access.
- Loosen the two screws ③ fixing the solenoid valve to the rear panel. Press down the top locking ring of the solenoid valve to allow the valve to be pushed down onto the support.
- Turn the angled hose connector ④ upwards. Press the locking ring of the top angled hose connector ⑤ upwards and remove the outlet hose.
- Turn this angled hose connector ⑤ upwards to ensure that any residual water cannot escape from the measuring chamber. Now simply pull the measuring chamber off the retaining bolts towards the front.
- To drain the measuring chamber, turn the bottom angled hose connector ④ downwards and let the residual water drain off.

#### Cleaning the measuring chamber

Clean the measuring chamber with a cleaning agent suitable for de-calcification and rust removal. Flush the measuring chamber thoroughly after cleaning.

## Cleaning the sight glasses

---



### Removal and installation of the sight glass windows

If the sight glass windows cannot be removed from the measurement chamber, open the measurement chamber cover and then carefully push them out from the inside. Do not apply excessive force and do not use sharp objects that may damage the sight glass windows.

Ensure tension-free mounting of the sight glass windows. Tighten the screws equally alternating both sides. Otherwise, the sight glass windows may break.

---

If the instrument has been used to measure hard water for a longer period of time, a hard-to-remove film may have formed on the sight-glass windows. Use cleaning spirit to remove this sticky film.

### Installing and operating the measuring chamber

- Switch the instrument off before installing the measuring chamber.
- Install the measuring chamber again. To do so, carry out the removal steps in reverse sequence.
- Connect the pump hose to the hose connector of the measuring chamber.
- When all assembly work has been completed, the pipeline system must be bled before the instrument can be operated again (see [Bleeding the indicator lines](#)).

### Cleaning the housing

The surface of the instrument housing is untreated. For this reason avoid soiling it with indicators, oil or grease. However, should the instrument housing become soiled, clean the surface with a normal plastic cleaner (never use other solvents).



## Pump head maintenance intervals

Replace the pump head:

- When the E4 indicator, "Maintenance message pump head" flashes.

### NOTE

#### Replacing the pump head

We advise replacing the pump head after approx. 2 years because the pump head's performance can decrease due to wear.

## Pump head maintenance message

The effective runtime of the pump head is counted during operation. After 150 hours of operation, the LED E4 flashes with the maintenance message for the pump head. This runtime for the pump will be reached during normal operation (analysis interval every 10 min.) after approx. 2 years or 54000 analyses.

- Switch off the instrument to acknowledge the message.
- Press and hold key 4 (horn) when switching on the instrument. The operating time of the pump head is then reset to 0.

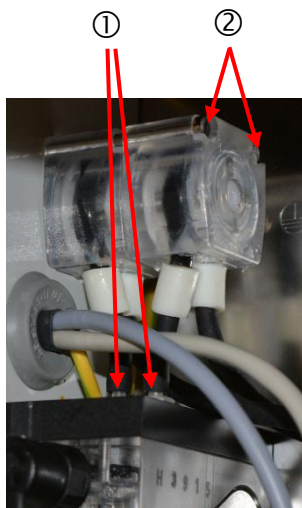

### NOTE

## Replacing the pump head

To replace the pump head proceed as follows:

- Disconnect the device from the power supply.
- Pull the hoses off both hose connectors ①.
- Loosen the two screws ② at the pump head and pull both pump heads off the motor shaft.
- To install the new pump heads, carry out the steps in reverse sequence.
- Connect hose A with reagent bottle A and hose B with reagent bottle B.
- Now connect the two short tubes with the measuring chamber.
- Press key 4 (horn) and keep it pressed while switching on.
- Bleed the indicator pipes before carrying out further analyses.

#### Twist protection

Pay attention to the twist protection on the motor shaft and the pump heads! The locating lugs on the pump head should engage with the holes provided in the housing so that the long end of the hose points towards the right.

## Bleeding the indicator lines

---



### **During maintenance, note the following:**

Water leaks from seals can result in damage to instrument components!

Please check the instrument for leaks before carrying out the first analysis:

- To this effect switch the instrument to standby mode.
  - Flush the pipeline system by a short activation of key 2 (Flush).
  - Check all connections and seals for leaks.
- 

To ensure that indicator is available for the initial analyses, the intake hose and the transport hose must be filled with indicator from the pump up to the measuring chamber.

- Switch on the instrument and press key 3 (standby). The standby function is switched on or off via a short key press. The LED above the key flashes if the function is active.
- Press key 1 (manual) for longer (approx. 2 seconds) to bleed the lines. The dosing pump starts to run.
- Let the pump run until no more bubbles escape from the dosing needle. Then press key 1 (manual) again for approx. 2 seconds to switch off the pump.

During operation, the pump automatically extracts the indicator.

## Replacing the motor block in a Testomat<sup>®</sup> 808

To replace the gear motor you need a gear motor for dosing pump of Testomat<sup>®</sup> 808 (Art. no. 100494).

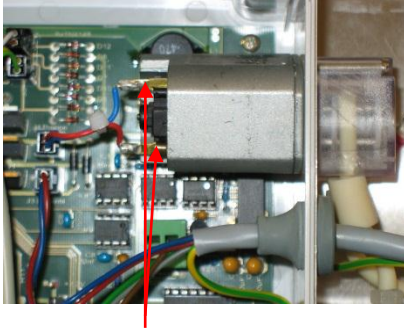

①

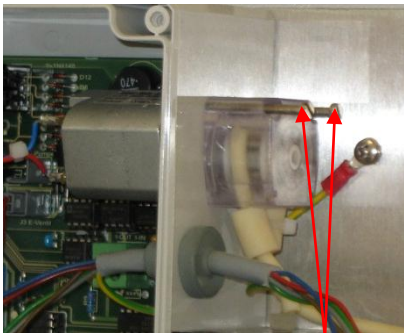

②

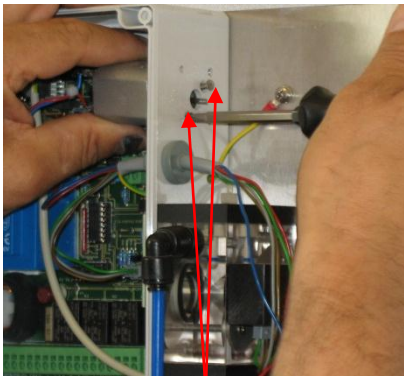

③

**NOTE**

### Disassemble the gear motor

For disassembling, please proceed as follows:

- Disconnect the device from the power supply.
- Close the water supply from the supply line to the Testomat<sup>®</sup> 808 SiO<sub>2</sub>.
- Open the cover.
- Open the door of the terminal box.
- Pull off the plug connections ① for the power supply of the Testomat<sup>®</sup> 808 SiO<sub>2</sub> (from socket J4 pump on motherboard).
- Now remove the pump head. Begin with pulling off the tubes from the dosing needle and the indicator bottle.
- Loosen the 2 fastening screws ② of the pump head.
- Pull off the pump head from the motor shaft.
- Loosen and remove the 2 screws ③ of the motor block.
- Remove the gear motor.

### Assemble the new gear motor

Assemble the new gear motor in reverse order.

- Insert the motor block and tighten the 2 fastening screws ③.
- Mount the pump head onto the shaft. Observe the anti-twist guard.

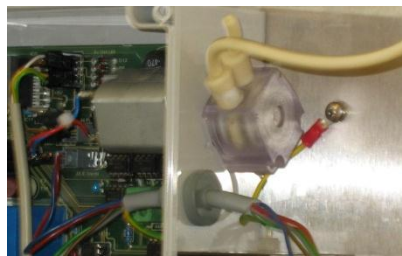

### Anti-twist guard

Please observe the anti-twist guard on the motor shaft and the pump head during installation! The drill hole and the shaft each have a flat surface and only fit together in one position. Carefully turn the pump head into the correct position until the snap-in noses snap into the provided drill holes in the housing.

**NOTE**

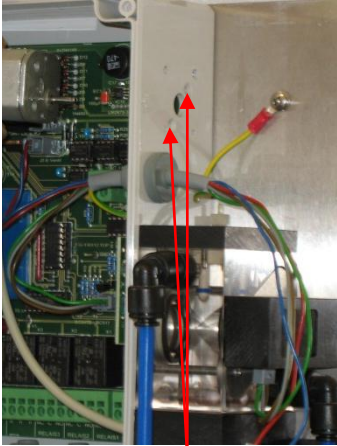

④

- Tighten both screws ② of the pump head.

**Tighten screw without hard pressure!**

Make sure that you don't exercise too much pressure on the tapped bores. It is possible that the tapped bores ④ will be pushed out of the housing under hard pressure.

- Connect the long tube with the indicator bottle and the short tube with the measuring chamber.
- Plug on the plug connections ① for the power supply of the Testomat® 808 SiO<sub>2</sub> (from socket J4 pump on motherboard).
- Close the door of the terminal box.
- Close the cover.
- Open the water supply to the Testomat® 808 SiO<sub>2</sub>.
- Put the device into operation again.
- Depressurise the lines before performing any further analyses.

**Synchronising a new optics board**

After replacing the optics board or LED holder, you need to perform a synchronisation in the device. Otherwise the device cannot find any measurement values.

**NOTE**

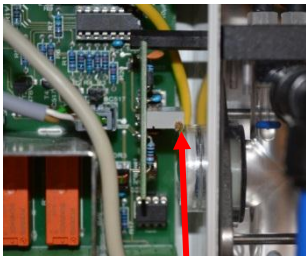

①

**A full set can be installed without synchronisation**

If you are not able to perform this synchronisation, use the full set of an optics board and LED holder (Article no. 40365), which is synchronised at the factory, or contact your service partner.

- Start the ServiceMonitor (page 13).
- Start the synchronisation program (page 13).
- Press button 2 (flushing). AD values are displayed in the Service-Monitor.
- Turn the screw ① at the potentiometer on the optics boards until a value of **900 digits ±10** is displayed.
- Press button 2 (flushing) to end the synchronisation process.
- Press button 4 (horn) to monitor the synchronisation. The green LED above button 1 lights up. After a short time, the yellow LED above button 2 also lights up.
- Approximately **55 digits** should now be displayed on the Service-Monitor.

This means synchronisation has been completed successfully.

# Service programs

## Test and adjustment program

Using the **Testomat® 808 SiO2 ServiceMonitor** software, you are able to read data and to reset the meter readings (information on downloading the software can be found on page 6).

To do this, the software must be saved on a notebook that is connected to the Testomat® 808 SiO2 with a null modem cable via the RS232 interface. If the notebook doesn't have a serial interface, then please use a USB 2 > serial adapter (Article no. 32286).

### Access to the Test and Adjustment program

- Keep key 1 (manual start) pressed and switch on the power supply.  
The POWER LED flashes.
- Release key 1.

#### Alternatively

- Once the device is switched on, keep key 1 (manual start) pressed and press the Reset button once briefly.  
The POWER LED flashes.
- Release key 1.

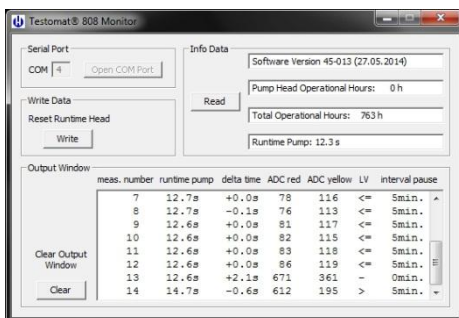
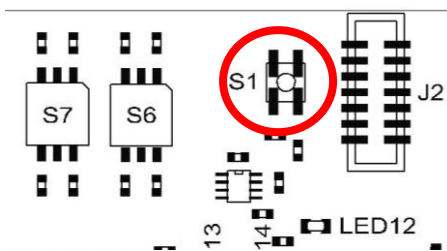

### Operating the T808 Monitor Program

- Open the "T808 SiO2 ServiceMonitor" program on your notebook by double clicking.
- Under **Serial Port**, select the COM port to which the Testomat® 808 SiO2 is connected.
- Click **Read** to receive status information about the device in the "Info-Data" section.
- With **Reset Runtime Head**, you can set the counter of the pump head operating hours meter to 0.
- In the **Output Window** field, either the ADC value (for testing of the blueish index) or the value of the V level (for the clear water comparison) will be displayed (see the description of the key functions on pages 14-16).
- To delete the **Output Window** field, click **Clear**.



## NOTE

## Functions of keys in the test program

**Manual start key** (first key from the left, short press of the key):

### Calling up the serial interface

- Operation via the serial interface is no longer possible from this point. A change to the serial interface is only possible after the sixth key activation.

Number of key activations	Function
first key activation	<p>=&gt; The LED above key no. 1 (Manual start/Bleed) is lit.</p> <p>The input, "Delete Ext." is read in: when contact is established, the LED above key 4 (Alarm) is lit.</p> <p>The input, "Stop" is read in: when contact is established, the LED above key 3 is lit (Pause/BOB).</p>
second key activation	=> Only K1 on, LED above key 1 (Manual start/Bleed) on, LED K1 on.
third key activation	=> Only K2 on, LED above key 1 (Manual start/Bleed) on, LED K2 on.
fourth key activation	=> Only K3 on, LEDs above key 1 (Manual start/Bleed) and key 4 (Alarm) on.
fifth key activation	=> All display LEDs are lit in succession and then simultaneously. The input valve opens, all relays operate, the rotating field operates, the measuring LEDs are switched on, the pump is operating and 20mA are supplied at the power interface.
sixth key activation	=> Everything is switched off and the power interface supplies 5 mA. The POWER LED and the threshold LED "Measurement good" flash.



**Internal flushing** key (second key from the left, short press of the key):

**NOTE**

**Calling up the serial interface**

- Operation via the serial interface is no longer possible from this point. A change to the serial interface is only possible after the fourth key activation.

Number of key activations	Function
first key activation	=> Measurement LED1 (blue) on, LED above key 2 (Flush internal/external) on, LED above key 3 (Pause/BOB) on.
second key activation Back to test program	=> The message, "ADC value BPW20:" with attached measurement value is displayed. The measurement value changes by adjusting the potentiometer on the optics board. Target value ≈ 900

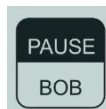

**Standby** key (third key from the left, short press of the key):

**NOTE**

**Calling up the serial interface**

- Operation via the serial interface is no longer possible from this point. A change to the serial interface is only possible after the first key activation.

Number of key activations	Function
first key activation	=> Checking the watchdog timer: the LED above key 4 (Alarm) and the POWER LED flash. A reset is initiated after 12 seconds and the instrument starts in normal operating mode (the POWER LED is lit).

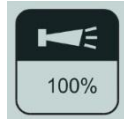

**Quit Alarm** key (fourth key from the left, short press of the key):

### **Auto-adjustment**

Prerequisite: clear water in the measurement chamber.

A measurement is carried out using the measurement LED 1 (blue). The measurement amplifier gain is adjusted by means of an electronic potentiometer. The LED above key 1 (Manual start / Bleed) is lit.

If the adjustment is successful, the potentiometer setting will be stored permanently. The LED above key 2 (Flush internal/external) is also lit.

If the comparison fails the LED above key 1 (Manual start/Bleed) flashes.

### **Serial interface settings:**

- 9600 baud
- 8 bit
- 1 stop bit
- No parity

### **Zeroing the first pump head operating hours counter**

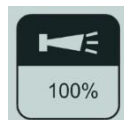

- Press and hold the horn key and switch the instrument on. The first pump head operating hours counter is set to zero and the maintenance indicator (LED E4) no longer flashes.

The pump head operating hours counter registers up to a maximum of 150 hrs.



## Updating the firmware

We recommend you to update the firmware installed on your Testomat<sup>®</sup> 808 SiO2 at regular intervals. Proceed as follows:

- Download the "T808\_FlashTool\_SelfExtractor.exe" software and the latest firmware update from the download page of our homepage [www.heyl.de](http://www.heyl.de) and save both on your notebook.
- Unzip the file on your notebook.  
Ensure that the firmware update and T808\_FlashTool have been saved in the same folder in the notebook.
- Using the null modem cable, connect the serial interface of your notebook to the serial interface of the Testomat<sup>®</sup> 808 SiO2 device. If the notebook doesn't have a serial interface, then please use a USB > serial adapter (Article no. 32286).
- Disconnect the Testomat<sup>®</sup> 808 SiO2 device from the power supply.
- Move slide switch T1 ① at the controller board to switch position RIGHT.

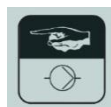
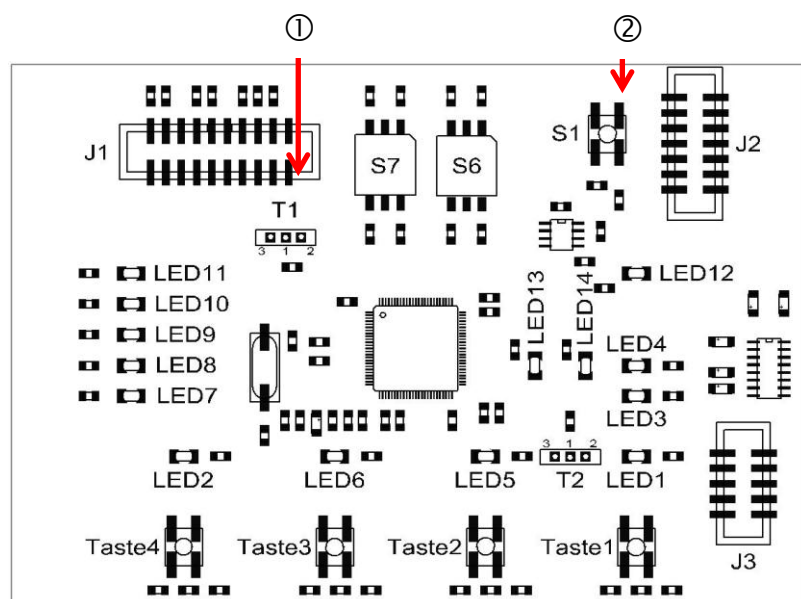

- Keep the Manual button pressed and switch on the power supply for the Testomat<sup>®</sup> 808 SiO2 device.

- Double click on the "T808\_Flash.bat" file. The following screen will be displayed:



```
C:\Windows\system32\cmd.exe
Available firmware files:
T808_45-012.hex
type in COM port number:
```

- Specify the COM-Port that is being used to connect the Testomat<sup>®</sup> 808 to the notebook.
- Confirm the entry by pressing Enter.
- Specify the file name for the firmware update. All available files will be displayed under "Available firmware files:". If there are no files displayed, download the current firmware from our homepage and save it in the same folder where the "T808\_Flash.bat" file is saved.
- Confirm the entry by pressing Enter.



```
C:\Windows\system32\cmd.exe
Available firmware files:
T808_45-012.hex
type in COM port number: 3
type in filename: T808_45-012.hex_
```

- If you have entered an incorrect COM-Port or an incorrect file name for the firmware update then you will receive an error message informing you of this.

## Error correction

### 1. Error E4 “Visual problem 1”

LED performance too low, too little light (or hardware fault)

Proposed solution:

- Check whether the water is cloudy. Excess clouding can compromise the measurement.
- Check whether the measuring chamber/sight-glass window is soiled.  
Replace the sight glass made of glass to sight glass made of PMMA, if the silicate content in the sample water is higher than 15 mg/l and a white film is deposited on the glass.
- The sensor or the LED could be damaged.
- Check for a lack of water.
- Check whether the measuring chamber and the LED fitting have been installed correctly. These elements can loosen during transport. The measurement is no longer being carried out correctly.
- If necessary, carry out a visual adjustment as described in the chapter, “Test and Adjustment program”.

### 2. Error E3 “Visual problem 2”

LED performance too high, too much light (or hardware fault)

Proposed solution:

- Close the housing cover. The surroundings are too bright (sunlight) and compromise the measurement.
- The sensor or the LED could be damaged.
- If necessary, carry out a visual adjustment as described in the chapter, “Test and Adjustment program”.

### 3. Error E2 “MST analysis”

Proposed solution:

- Check whether the indicator bottle is empty.
- Does the indicator display correspond to the indicator volume in the bottle?
- Check the indicator. Only use indicators which we have approved for use in the Testomat<sup>®</sup> 808. Indicators for other Testomat instruments produce erroneous measurements or the error, “MST analysis”.
- Check whether the stirring bar is present and turns.
- Check whether the pump supplies indicator.
- Check whether the dosing needle is blocked or its O-ring is damaged. Make sure that the suction and pressure hoses do not draw

secondary air. Check the suction lance. Make sure that no air bubbles are escaping from the dosing needle.

- Check fuse F3 and replace it. If the fuse continues to trip, replace the pump motor.

#### 4. Error E1 “Lack of water”

Proposed solution:

- Check water hoses for leaks.
- Are the water hoses properly connected?
- Are all shut-off valves in supply pipes open?
- Please ensure that no foreign particles have caused a blockage.

#### Defective pump motor

The F4 fuse on the main board protects the pump motor. After a short circuit, the LED next to fuse F4 is off.

- Exchange the pump motor and F4 fuse.
- Check that the green LED is lit again.

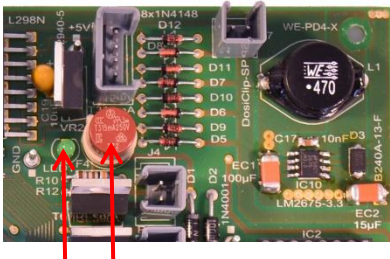

LED F4

**NOTE**

---

#### Monitoring the pump motor

The pump motor can also stop without a short circuit. This will not trip the F4 fuse. In the event of a **low indicator level** (measurement disruption analysis), always check the pump motor by pressing the ‘manual’ button down for 2 seconds. If the motor no longer turns, replace it.

---

## Spare parts list

Art. no.	Spare parts – measuring chamber
33777	Flat seal 24x2
40170	Sight-glass window 30x3
40176	Sight-glass window holder
33253	Screw M3x40, A2, DIN 965
33246	Screw M3x12
37533	Measuring chamber Testomat 808 SiO <sub>2</sub> , complete (1 – 4 bar)
37752	Measuring chamber Testomat 808 SiO <sub>2</sub> , complete (0.3 – 1 bar)
37679	Measuring chamber cover
37680	Dosing needle T808 SiO <sub>2</sub>
40050	Magnetic stirrer, processed
40157	Angled plug-in connector G1/8"-6
33797	O-ring 2.8x1.78
11264	O-ring 4.5x1.5
11245	O-ring 1.78x1.78
Art. no.	Spare parts - instrument
40367	Optical board Testomat 808 SiO <sub>2</sub> *, complete
37322	Controller board Testomat 808, complete
37324	Base circuit board Testomat 808, complete
40366	LED holder Testomat 808 SiO <sub>2</sub> *, complete
40365	Full set with optics board and LED holder*
37570	Solenoid valve Testomat 808
37578	Pump head Testomat 808

31592	Fuse, soldered T1.0A
31593	Fuse, soldered T0.8A
31585	Fuse, soldered T0.315A
31584	Fuse, soldered T0.2A
31595	Fuse, soldered T0.1A
31666	Fuse GS-T, 5x20, T A4
37734	Cable ducting M16 x 1,5
37735	Nut for cable ducting M16 x 1,5
37736	Blanking plug for cable ducting
Art. no.	Bottle connection/Suction device
37579	Bottle insert for screw cap and push-fit suction tube, 500 ml bottle
37580	Bottle insert for screw cap and push-fit suction tube, 100 ml bottle
37643	Hose adapter
Art. no.	Special accessories
37583	Candle filter Testomat 808 complete
37584	Filter insert 100µm
37593	Plug D = 6
37602	Pressure regulator, complete for Testomat
270343	Repair and Service Kit Testomat 808 SiO <sub>2</sub>
270351	Service Set Testomat 808
100494	Gear motor for dosing pump

\* The full set of an optics board and LED holder is synchronised at the factory and can be used directly after installation. When replacing the optics board or LED holder individually, a synchronisation must be performed in the device, see chapter [Synchronising a new optics board](#).

### NOTE

#### Bottle connection

Testomat® 808 SiO<sub>2</sub> is delivered with a bottle connection for a 500 ml bottle. Please order a bottle connection for a 100 ml bottle upon request.

# Component positions

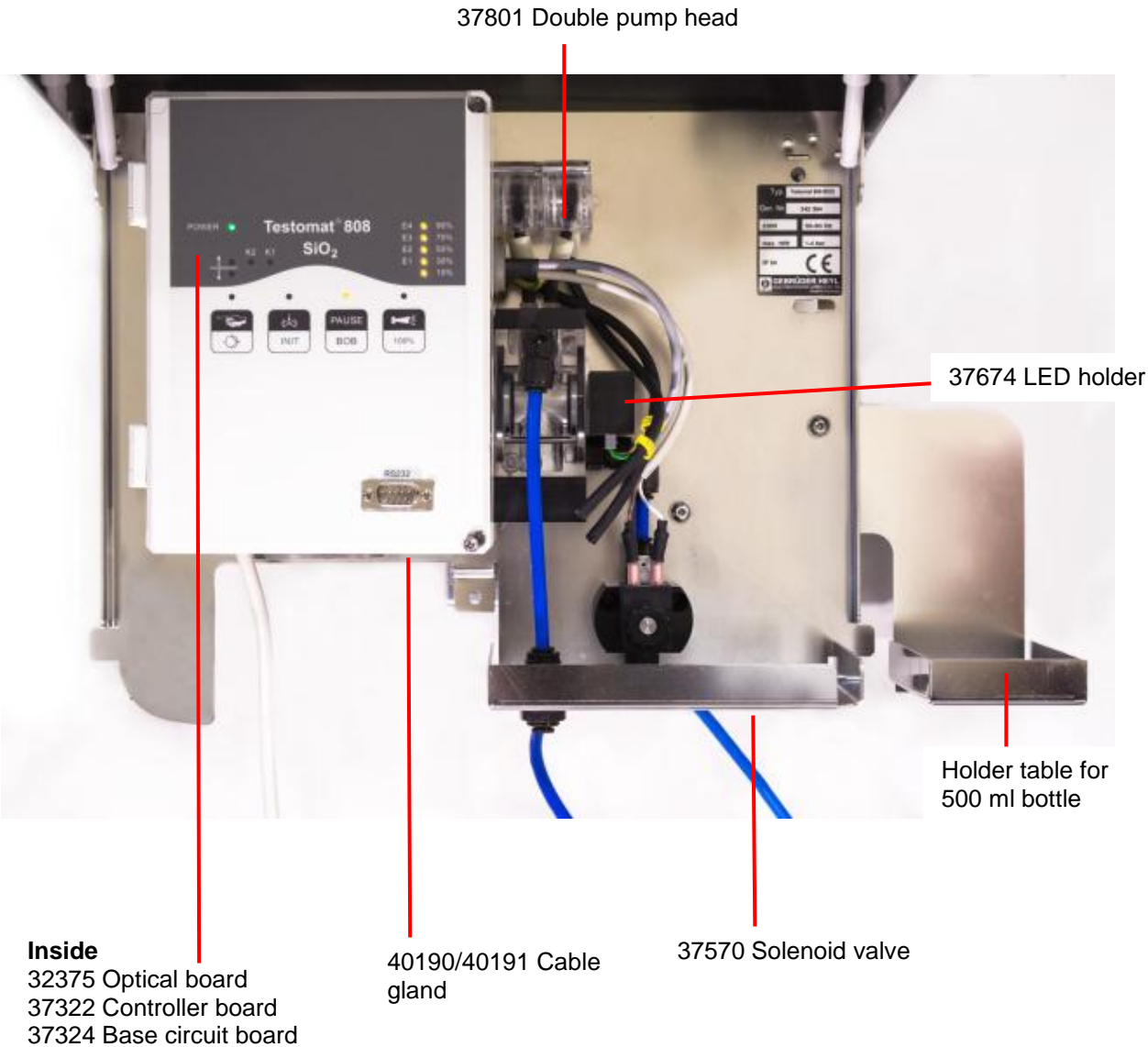

## Measuring chamber components

- |    |                           |                             |
|----|---------------------------|-----------------------------|
| 1  | Measuring chamber         | (Article no 37533 (1-4bar)) |
| 2  | Sight-glass window holder | (Article no. 40176)         |
| 3  | Magnetic stirrer          | (Article no. 40050)         |
| 4  | Measuring chamber cover   | (Article no. 37679)         |
| 5  | Dosing needle             | (Article no. 37680)         |
| 6  | Screw M3x40               | (Article no. 33253)         |
| 7  | Screw M3x12               | (Article no. 33246)         |
| 8  | Flat seal 24x2            | (Article no. 33777)         |
| 9  | Sight-glass window 30x3   | (Article no. 40170)         |
| 10 | Hose adapter              | (Article no. 37643)         |
| 11 | Angled plug in connector  | (Article no. 40157)         |
| 12 | O-ring 3.8x1.78           | (Article no. 33797)         |
| 13 | O-ring 4.5x1.5            | (Article no. 11264)         |
| 14 | O-ring 1.78x1.78          | (Article no. 11245)         |

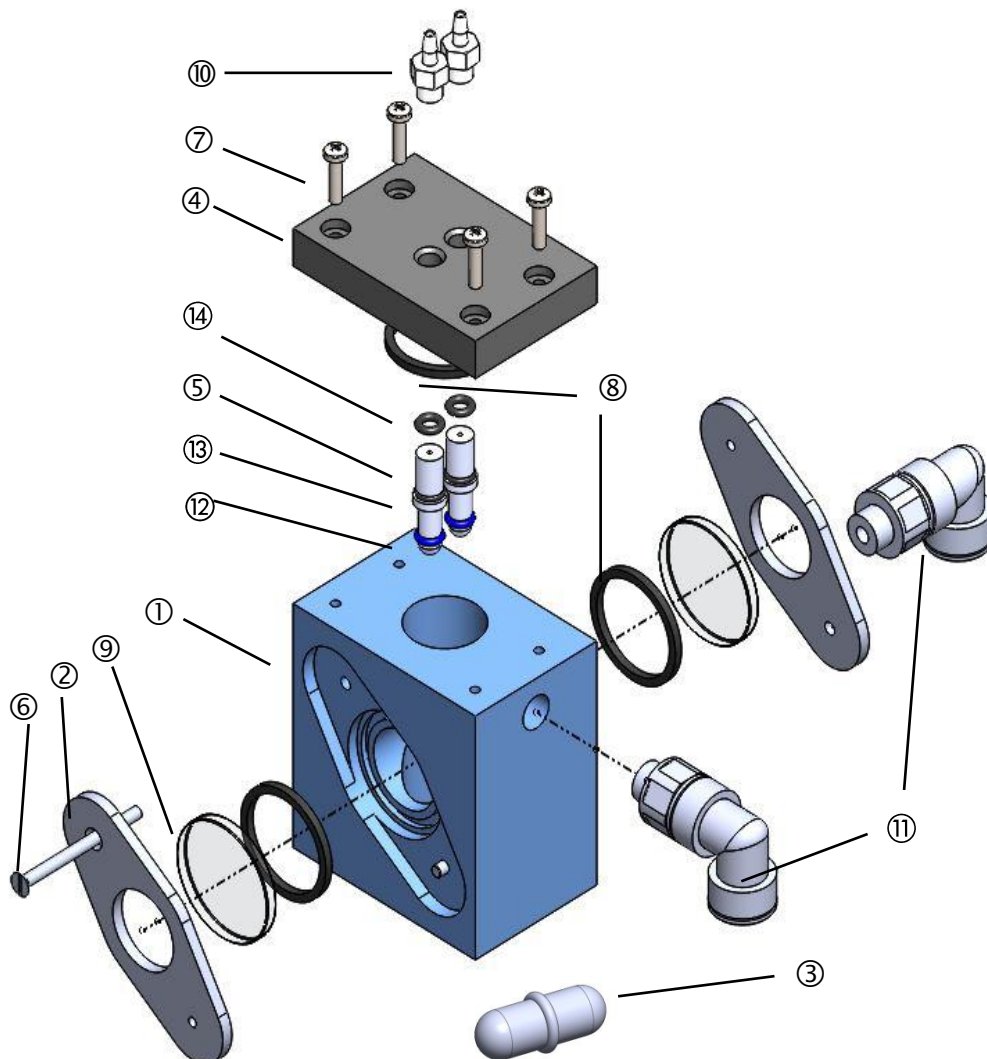

## Location of fuses

The following fuses can be found on the base circuit board.



No.	Designation	Function	Comment	Art. no.
1	F1 F2	Relay protection fuse	4 A	31582
2	F3	Primary fuse	230 V / 0,1 A 115 V / 0,2 A 24 V / 1 A	31595 31584 31592
3	F4	Secondary fuse	1 A	31592
4	F5	Relay protection pump motor	0.315 A	31585

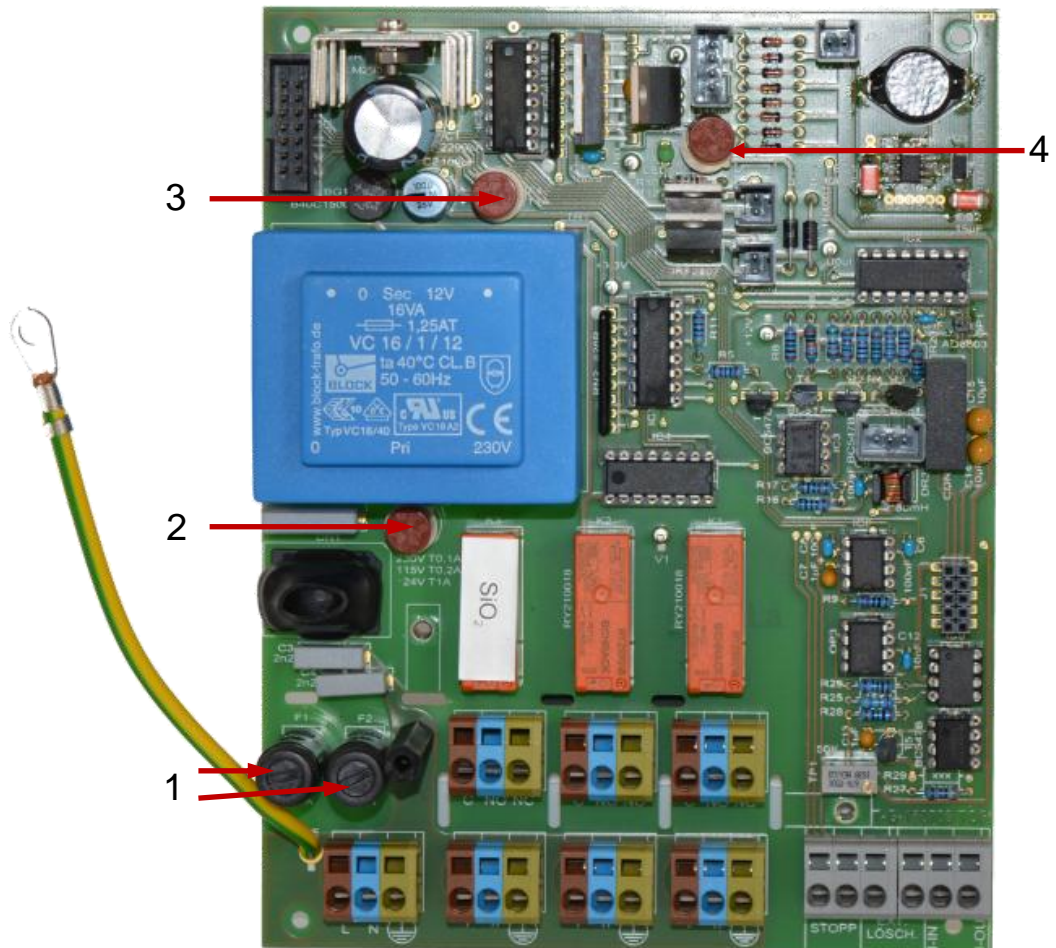



# Testomat® 808 SiO2 checklist

Dear customers and service technicians,

This check list cannot replace your expertise or extensive experience in fault resolution. It is intended to support fast and systematic error diagnosis and error documentation. This list does not claim to be complete. We are therefore always grateful for any advice and information you may be able to provide. General user instructions can be found on the rear of this check list.

The Instrument Manufacturer

Block 1 / Plant and instrument data

		Instrument type	Instrument number	Indicator type	Software status

Block 2 / Error message and error history

Please mark appropriately (X)

What error messages does the instrument display? (Keys "3" (Standby) and "4" (horn)=> Operating instructions)			( LED )
Is the LED above key 4 flashing or lit?	Flashing	Lit	
Are other LEDs lit? Which ones?	Yes	No	( LED )

Block 3 / Visual inspection and functional test

Please mark appropriately (X)

If applicable, values / comments

Is the correct mains voltage (according to the rating plate) being supplied to the instrument?	Yes	No	
Does water flow out of the discharge hose during analysis?	Yes	No	
Are the measuring chamber and sight glasses clean?	Yes	No	
Are the measuring chamber and water hoses watertight?	Yes	No	
Does the indicator still have shelf life remaining? (See expiry date on the indicator bottle)	Yes	No	Expiry date:
Has the correct bottle size been set?	Yes	No	Size: 100 ml / 500 ml
Is the water pressure within the prescribed limits (400 ml/min)? (See the instrument's rating plate)	Yes	No	System pressure:
Has the outlet been installed free of back pressure along its total length? (No "siphon effect"!!)	Yes	No	
Is the outlet hose clear? (Contamination by micro organisms or similar)	Yes	No	
Has it been ensured that fresh measuring water reaches the measuring chamber and that measurement is carried out within the flushing time of 10 seconds?	Yes	No	
Are the dosing pump hoses free of air bubbles? (Operate the pump manually / carry out a manual analysis)	Yes	No	

**CARRYING OUT A MANUAL ANALYSIS**

Does the indicator pump supply a dose when an analysis is triggered?	Yes	No	
Is the indicator properly mixed in the water during the dosing process in the measuring chamber? Check the magnetic stirring bar!	Yes	No	

**PROGRAMMING DATA / OPERATING CONDITIONS**

Is the Testomat instrument constantly supplied with mains power - except during maintenance work/emergencies? (Occasional switching off only by means of the "Standby" or "Input stop" keys!)	Yes	No	See "General instructions for operating the Testomat® 808"
--	-----	----	--

Please refer to "Error messages / Troubleshooting" in the **operating instructions** for further information on error messages and possible causes of faults.

Further functional tests and service instructions can be found in the **maintenance manual**

If you have examined the instrument with the aid of the checklist and answered "Yes" to all questions in Block 3 it can be assumed that its functions are operating correctly.

We recommend that you carry out all tests contained in this checklist at every service and when faults have occurred.

## General user instructions for Testomat<sup>®</sup> 808 SiO<sub>2</sub>

### Basic design of the instrument

As a monitoring instrument, the Testomat<sup>®</sup> 808 SiO<sub>2</sub> has been designed for permanently monitoring water by means of daily measurements. Several measurements per day are assumed under standard conditions of use. Should the instruments be operated with longer periods between analyses (interval times), attention must be paid to appropriate flushing times and flushing water volumes respectively. In case of non-compliance residual or mixed water from the hoses may be measured, leading to thresholds being exceeded. The indicator expiry date can also be exceeded under certain circumstances.

Long interval times often make little sense. It may be that avoidable problems arise instead of achieving desired savings. The water requirement per analysis also amounts to only 80 to 150 ml.

### Switching off the instruments / Stopping the measurements

Interruptions to measurements should only be made using the functions, "Standby" (at the instrument) and "Stop" (external) provided for this purpose. Switching the instruments off by **disconnecting them from the mains does not make sense** because

- when disconnected from the mains, the instruments can stop with their measuring chambers full of water resulting in heavy soiling of measuring chamber, sight glasses and stirring rod

In this case, malfunctions due to an improper restart and unclear error messages cannot be excluded. However, if instruments are switched off for several days, care should be taken to ensure that measuring chambers are only filled with water and the restart is carried out in the same way as a first commissioning. At least the dosing pump should be operated manually until the hose is emptied of air.

### Initial start-up of new plants

For new plants we recommend **flushing the pipelines** thoroughly before connecting the instrument. We recommend fitting a fine filter to the water supply hose - see our range of products. This filter should be cleaned or replaced at regular intervals because solid particles can clog the filter when operated for longer periods. If this is not noticed, malfunctions and error messages caused by the reduced flow of water cannot be excluded. In case of a correspondingly high concentration, particles can reach the solenoid valve despite the presence of a filter. This could compromise its function.

### Operation/Indicator

The proper operation of Testomat instruments can only be assured **where original Heyl Testomat<sup>®</sup> indicators are used**. These indicators permit an exact analytic measurement of the smallest quantities of substances. As for all reactive chemical substances, their effectiveness is also influenced by environmental conditions.

The shelf life data which we have calculated are based on use and storage at room temperature and the exclusion of direct light. Deviating influencing factors and environmental parameters or those not tested by us can result in a variation in the shelf life threshold.

The indicator must be replaced upon the expiry of its shelf life in order to guarantee its reliable function. Please note the expiry date on the bottle's label.

### Water inlet

Compliance with the water inlet pressure limits recorded on the rating plate is essential. Should the water flow be insufficient, (e.g. also in case the filter is soiled) there is no proper exchange of measuring water and therefore a clear analysis cannot be assured.

The measuring process can be repeated several times and ultimately result in error messages.

### Water outlet

In assembly, care should be taken to ensure a **discharge free of back pressure** as described in the operating instructions, "Water outlet".



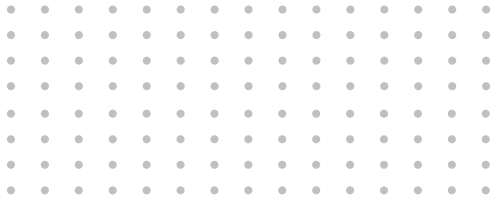

Gebrüder Heyl  
Analysentechnik GmbH & Co. KG  
Orleansstraße 75b  
D 31135 Hildesheim  
[www.hey1.de](http://www.hey1.de)

Serviceanleitung\_808\_Si\_GB\_161206.docx

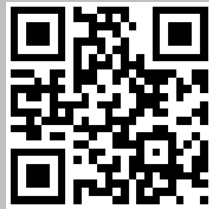

Scan the code and  
visit us on our website!