

# Operating Instructions Testomat 2000<sup>®</sup> DUO

Online analysis instrument for  
water hardness, carbonate hard-  
ness, p-value or minus m-value



# Contents

<b>Contents</b> .....	<b>2</b>
<b>Important safety information</b> .....	<b>4</b>
Intended use .....	4
Qualification of the staff .....	4
Warning notices in these instructions .....	5
Further documents .....	5
<b>Pay particular attention to</b> .....	<b>5</b>
General instructions .....	5
Installation .....	6
Operation .....	6
After switch-off and longer downtime.....	6
Cleaning .....	6
De-installation .....	6
Disposal .....	6
<b>Scope of delivery</b> .....	<b>7</b>
<b>Performance specifications</b> .....	<b>7</b>
Indicators for Testomat 2000® DUO instruments .....	8
<b>Application instructions</b> .....	<b>9</b>
<b>Installation</b> .....	<b>10</b>
Operating Testomat 2000® DUO in the pressure range 0.3 to 1 bar..	10
Installing Testomat 2000® DUO .....	10
Connecting the water inlet and outlet .....	11
Water inlet .....	11
Water outlet.....	11
Connecting the power supply and devices .....	12
Block diagram Testomat 2000® DUO .....	12
Internal design Testomat 2000® DUO.....	13
Connecting the mains voltage.....	14
Connecting the plant components .....	15
Connecting the inputs and outputs .....	16
<b>Commissioning</b> .....	<b>17</b>
Inserting the indicator bottle.....	17
Extracting the indicator .....	17
Opening the water inlet .....	17
Instrument settings and data input.....	18
<b>Functions of the operating and display elements</b> .....	<b>18</b>
Switching Testomat 2000® DUO on/off .....	18
Display functions .....	19
Operating elements and function keys .....	20
Operating system .....	21
<b>Password protection and basic program</b> .....	<b>22</b>
Entering basic program data.....	22
Selecting the indicator and the bottle size .....	22
Selecting the operating mode .....	23
Selecting the display unit(s) .....	24
Measuring point or parameter selection .....	24
<b>Entering further basic program data</b> .....	<b>25</b>
Internal flushing.....	25
External flushing .....	25

Interval pause .....	26
Limit value monitoring .....	26
Hysteresis .....	27
Switch functions of the limit value outputs LV1 and LV2 .....	28
Switch function 0, duration .....	28
Switch function 1, impulse .....	28
Switch function 2, interval .....	28
Function IN1 .....	28
Water meter .....	28
Alarm / Message .....	29
Function AUX .....	29
Service II .....	30
Reset operating time .....	30
Maintenance interval .....	30
<b>Description of the signal inputs/outputs .....</b>	<b>31</b>
Interfaces (optional) .....	32
Monitoring a measuring point .....	33
Monitoring of two measuring points .....	33
Calculating the output currents .....	34
Serial interface RS232 .....	34
SD card data logger .....	35
<b>Description of the relay outputs .....</b>	<b>35</b>
Flushing (external flush valve) .....	35
LV1 and LV2 limit value outputs .....	35
Measuring points 1 or 2 (measuring point switch-over) .....	36
Alarm (fault message output) .....	37
Maintenance (output for maintenance message) .....	38
<b>Information menu "i" .....</b>	<b>39</b>
<b>Program menu "M" .....</b>	<b>40</b>
Structure of the basic program .....	42
<b>Error messages / Troubleshooting .....</b>	<b>43</b>
Further information .....	44
<b>Maintenance .....</b>	<b>45</b>
Description of maintenance work .....	45
Service instructions .....	46
<b>Testomat 2000<sup>®</sup> spare parts and accessories .....</b>	<b>47</b>
Accessories .....	48
<b>Technical data .....</b>	<b>49</b>



## Important safety information

- Please read these operating instructions carefully and completely prior to working with the instrument.
- Ensure that these operating instructions are always available for all users.
- These operating instructions must always be passed on to the new owner should Testomat 2000<sup>®</sup> DUO change hands.
- Always adhere to hazard warnings and safety tips when using reagents, chemicals and cleaning agents. Please adhere to the respective safety data sheet! Download the safety data sheets for the supplied reagents at <http://www.heyl.de>.

### Intended use

Testomat 2000<sup>®</sup> DUO is used for the automatic determination and monitoring of residual total hardness (water hardness), residual carbonate hardness, as well as the minus m-value and the p-value in water. The measurement parameters and the respective measuring range are determined by the indicator selection and according to the user programming.

- Always adhere to the performance limits stated in the section entitled "[Technical data](#)".
- Always observe the application areas/application limits of the indicators and the requirements of the medium being measured.

To ensure correct and intended usage, always read and understand these instructions, especially the section entitled "[Important safety information](#)", prior to use.

The instrument is not used as intended if

- it is used in areas not specified in these instructions,
- it is used in areas which do not correspond to the ones described in these instructions.

### Qualification of the staff

Assembly and commissioning require fundamental electrical and process engineering knowledge as well as knowledge of the respective technical terms. Assembly and commissioning should therefore only be carried out by a specialist or by an authorised individual supervised by a specialist.

A specialist is someone who due to his/her technical training, know-how and experience as well as knowledge of relevant regulations can assess assigned tasks, recognise potential hazards and ensure appropriate safety measures. A specialist should always adhere to the relevant technical regulations.

## Warning notices in these instructions

The warning notices in these instructions warn the user about potential dangers to individuals and property resulting from incorrect handling of the instrument. The warning notices are structured as follows:



### Description of the type or source of danger

Description of the consequences resulting from non-observance

- Preventive measures. Always adhere to these preventive measures.

“**DANGER**” indicates an immediate hazardous situation which, if not avoided, will result in death or serious injury.

“**WARNING**” indicates a potentially hazardous situation which, if not avoided, could result in death or serious injury.

“**CAUTION**” indicates a potentially hazardous situation which, if not avoided, could result in minor or moderate injuries or property damage.

“**NOTE**” indicates important information. If this information is not observed, it may result in an undesirable result or state.

### Further documents

Testomat 2000<sup>®</sup> DUO is a plant component. Therefore, always observe the maintenance manual of Testomat 2000<sup>®</sup> / Testomat 2000 ECO<sup>®</sup> and the documentation of the plant manufacturer.

## Pay particular attention to

### General instructions

- Please adhere to health and safety regulations, electrical equipment safety regulations, and environmental protection regulations valid in the country of use and at the installation site.
- Adhere to national and local regulations during installation and commissioning.
- Always protect the instrument against moisture and humidity. It should never come into contact with condensation or splash water.
- Do not carry out any changes or actions at the instrument which are not described in these instructions; failure to adhere to these instructions will negatively affect any warranty claims that you make thereafter.



**WARNING****NOTE**

## Installation

- Always completely disconnect the relevant plant part before installing the instrument or connecting/disconnecting it to/from the power supply. Secure the plant against reconnection.
- Only connect the instrument to the mains voltage specified on the rating plate.
- Always observe technical data and ambient parameters.
- Testomat 2000<sup>®</sup> DUO requires an interference free and stable power supply. If necessary, use a mains filter to protect Testomat 2000<sup>®</sup> DUO against interference voltages caused, e.g., by solenoid valves or large motors. Never lay connecting cables parallel to power cables.

## Operation

- Ensure that the maximum electrical load capacity of the relay outputs is never exceeded.
- Immediately switch off Testomat 2000<sup>®</sup> DUO and contact service staff if malfunctioning occurs. The warranty will be void if you tamper with or attempt to repair Testomat 2000<sup>®</sup> DUO. Repairs must be carried out by authorised service staff.

## After switch-off and longer downtime

- Ventilate the indicator leads as described in the start-up, because longer downtimes (more than 6 hours) can cause the indicator in the leads to retract.
- Do not switch off the appliance for longer periods (e.g. over the weekend) via the start/stop output. The indicator can retract from the leads. This results in measurement errors after the appliance is switched on.

## Cleaning

- Only use a dry, lint-free cloth for cleaning.

## De-installation

- Prior to de-installing a defective instrument, always write down a description of the error (failure effect). It is only possible to repair a defective instrument (irrespective of the warranty period) if it has been de-installed and returned to us with a description of the error.

## Disposal

- Dispose of the instrument in accordance with national regulations.

## Scope of delivery

- 1 Testomat 2000<sup>®</sup> DUO
- 1 Plastic bag with two screw caps with a hole and an insert for the screw caps of the indicator bottles
- 1 operating instructions

## Performance specifications

Testomat 2000<sup>®</sup> DUO is used for the automatic determination and monitoring of residual total hardness (water hardness), residual carbonate hardness, as well as the minus m-value and the p-value in water. The instrument can be used to alternately measure two parameters at one measuring point or two measuring points with different (or the same) parameters. The measurement parameters and the respective measuring ranges are determined by the indicator selections and according to the user programming.

- Simple, menu-driven operating and programming via a plain text display
- Determinable measuring of residual hardness, total hardness, carbonate hardness, minus m-value, p-value via indicator selection
- Freely selectable hardness unit in °dH, °f, ppm CaCO<sub>3</sub> or mmol/l
- High measuring accuracy provided by a precise piston-dosing pump
- Analysis initiation:
  - Automatic interval operation  
(interval pause can be set from 0-99 minutes)
  - External control
  - Quantity dependent via impulse water meter
- Two independent limit values with hysteresis (1, 2 or 3 bad analyses) and settable switch functions
- Monitoring of two measuring points (change-over via external solenoid valves)
- Internal error documentation
- Programmable service address
- Programmable maintenance interval for a maintenance request
- Extended operating periods due to 500 ml indicator storage bottle
- **optional:**
  - Interface card (0/4-20 mA or 0/2-10 V)
  - Interface RS 232 (for a protocol printer)
  - SD Card datalogger

## Indicators for Testomat 2000® DUO instruments

		Parameter/Indicator type			
		Water hardness			
		TH 2005	TH 2025	TH 2100	TH 2250
Unit	<b>°dH</b> (resolution)	0.05 – 0.50 (0.01)	0.25 – 2.50 (0.05)	1.0 – 10.0 (0.2)	2.5 – 25.0 (0.5)
	<b>°f</b> (resolution)	0.09 – 0.89 (0.02)	0.45 – 4.48 (0.1)	1.8 – 17.9 (0.4)	4.5 – 44.8 (1.0)
	<b>ppm CaCO<sub>3</sub></b> (resolution)	0.89 – 8.93 (0.2)	4.5 – 44.8 (0.9)	18 - 179 (3.8)	45 - 448 (10)
	<b>mmol/l</b> (resolution)	0.01 – 0.09 (0.01)	0.04 – 0.45 (0.01)	0.18 – 1.79 (0.04)	0.45 – 4.48 (0.1)

		Parameter /Indicator type				
		Carbonate hardness		minus m-value	p-value	p-value
		TC 2050	TC 2100	TM 2005	TP 2010	TP 2100
Unit	<b>°dH</b> (resolution)	0.5 – 5.0 (0.5)	1.0 – 20.0 (1.0)	-	-	-
	<b>°f</b> (resolution)	0.90 – 8.96 (0.9)	1.8 – 35.8 (1.79)	-	-	-
	<b>ppm CaCO<sub>3</sub></b> (resolution)	8.9 – 89.5 (8.9)	18 - 358 (18)	-	-	-
	<b>mmol/l</b> (resolution)	0.18 – 1.79 (0.18)	0.36 – 7.16 (0.36)	0.05 – 0.50 (0.01)	0.1 – 1.5 (0.1)	1 - 15 (1)

Display, if measuring value is outside of range (for example TH2005):

At falling below: < 0,05°dH

At exceeding: > 0,50°dH

### NOTE

#### No dosage control!

When TC indicators are used to determine carbonate hardness, the device does not monitor the dosage. This concerns the indicators TC 2050 and TC 2100.

Ensure that there is always sufficient indicator available for the measurement. Set the indicator level to 100 % once you have exchanged an indicator bottle.



## Application instructions

- Wait at least 5 seconds before switching the instrument on and then off again at the main switch.
- In order for Testomat 2000<sup>®</sup> DUO to operate reliably, use Heyl Testomat 2000<sup>®</sup> indicators in the pH-range 4 – 10.5!
- With Testomat<sup>®</sup> instruments for water hardness monitoring, larger quantities of heavy metal ions in the softened water might influence the colour reaction, especially iron above 0.5 mg/l, copper above 0.1 mg/l and aluminium above 0.1 mg/l (brownish-red colour display).
- If the measuring water contains more than 20 mg/l CO<sub>2</sub> (carbonic acid), incorrect evaluations cannot be excluded.
- The concentration of influencing contents can be determined by using our colourimetric TESTOVAL<sup>®</sup> test kit.
- Careful handling of the instrument increases both its operational reliability and service life! Therefore, carry out a visual inspection at regular intervals as described below:
  - Has the use-by date of the indicator expired?
  - Are the hose connections of the dosing pump free of leaks?
  - Is there air inside the dosing hoses?
  - Are all the water connections free of leaks?
  - Are the doors of the instrument closed properly?
  - Is the instrument heavily soiled?
  - Are the measuring chamber and the drain duct/drain hose clean?
- Trouble-free operation is only possible when maintenance is carried out on a regular basis! For more information, please refer to the section entitled "[Maintenance](#)" and the "Maintenance manual of Testomat 2000<sup>®</sup> / Testomat 2000 ECO<sup>®</sup>".
- If problems occur, please refer to the section entitled "[Error messages/Troubleshooting](#)".

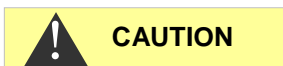

---

### No opening of the measuring chamber holder!

Do not open the measuring chamber holder. You cannot carry out any repairs in this area, but damage the device. If you open the measuring chamber holder, your warranty will expire.

---

## Installation



### Risks resulting from incorrect installation!

- Install Testomat 2000<sup>®</sup> DUO at a location where it is protected against dripping or splash water, dust and aggressive substances – e. g. in a switch cabinet or on a suitable wall.



### Information for trouble-free operation

- Install Testomat 2000<sup>®</sup> DUO vertically and without mechanical stress.
- Install Testomat 2000<sup>®</sup> DUO at a vibration-free site.

## Operating Testomat 2000<sup>®</sup> DUO in the pressure range 0.3 to 1 bar

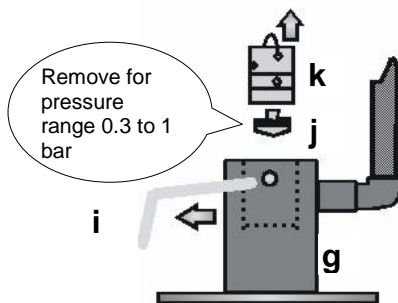

Prior to installation, please check whether lower operating pressure is required. The instrument is factory set for the operating range 1 to 8 bar. Remove the flow controller valve body **j** to operate the instrument in the operating range 0.3 to 1 bar (e.g. when using an aerator type R). This involves removing the retaining pin **i** from the controller / filter receiver **g**. Subsequently use the metal bracket to remove the controller plug **k** from the borehole. Subsequently remove the flow controller valve body **j** and reinsert the controller plug and the retaining pin.

## Installing Testomat 2000<sup>®</sup> DUO

Select an installation site where the water inlet hose can be kept as short as possible (max. 5 m).

- Please leave sufficient space on the left-hand side of the instrument to open the door.
- Drill the mounting holes as shown in the drawing on the left.
- Use three screws to attach the instrument at a suitable position in the switch cabinet or on a wall.

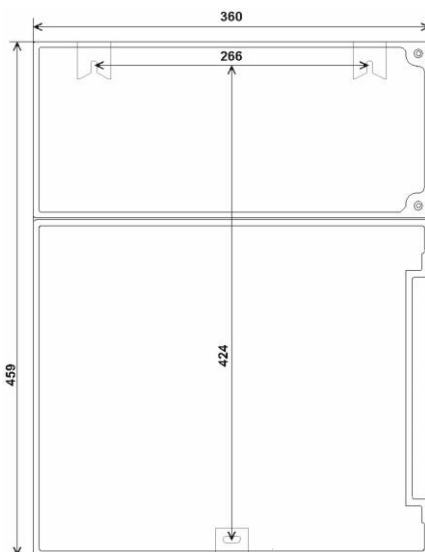

## Connecting the water inlet and outlet

### NOTE

#### Information for trouble-free operation

- The water pressure must be between 0.3 bar and 8 bar
- Avoid strong pressure fluctuations
- The measuring water temperature must be between 10 °C and 40 °C
- For temperatures above 40 °C, a cooler should be installed in the branch line of Testomat 2000® DUO.

#### Water inlet

The measuring water is taken from the main water line of the water treatment plant and fed to the inlet connection of Testomat 2000® DUO. The instrument is equipped with a plug connector for plastic hoses 6/4 x 1 (external diameter 6 mm/ internal diameter 4 mm, wall thickness 1 mm) as standard.

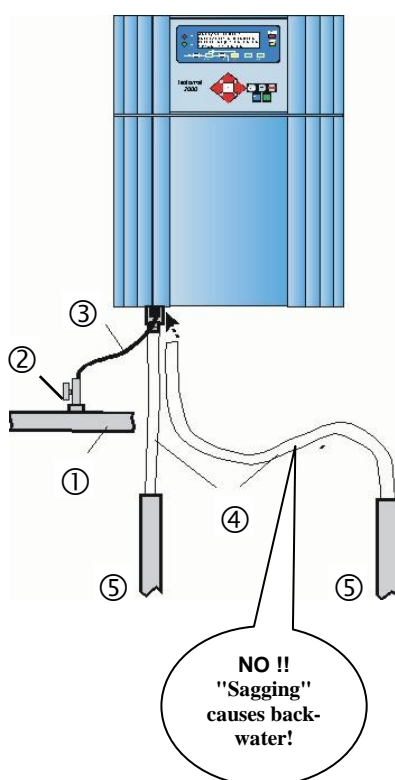

- Install the connection for the branch line of Testomat 2000® DUO directly at the main water line ① directly after the water treatment plant
- It is important that the branch line connection is laid vertically upwards in order to prevent dirt particles from entering the instrument from the main water line
- Install a manually operated shut-off valve ② Testomat 2000® DUO
- Use an opaque plastic hose 6/4 x 1 (max. length 5 m) for the water inlet ③
- Flush the inlet to remove any dirt particles

When operating within a pressure range of 0.3 to 1 bar or with a supply via a booster pump, please remove the valve body from the controller and the filter housing. The pump should have a feeding capacity of between 25 and 35 litres/hour and be resistant to the medium being measured.



### CAUTION

#### When using a cooler

- The hot water can cause burns and damage wetted parts of Testomat 2000® DUO.

#### Water outlet

The feed water flows through the measuring chamber to the drain via the outlet hose.

- Connect the outlet connection of Testomat 2000® DUO to an opaque outlet hose ④ (internal diameter 12 mm).
- Lay this hose without **backwater development** and any syphoning effect, e.g. via an open funnel, to the drain ⑥

## Connecting the power supply and devices



### WARNING

#### Risk of electric shocks during installation!

If the power supply is not disconnected prior to installation, it may result in personal injuries, destruction of the product or damage to plant parts.

- Always disconnect the relevant plant parts before installing Testomat 2000® DUO.
- Only use tested cables with sufficient cross-sections for the connections.

### NOTE

#### Risk of damages caused by electromagnetic fields!

- If Testomat 2000® DUO or the connecting cables are installed parallel to power cables or in close proximity to electromagnetic fields, the instrument may be damaged or measurements incorrect.
- Ensure that connecting cables are as short as possible.
- Always install connecting cables and power cables separately.
- Connect the instrument to the protective earth conductor (for 230/115 VAC).
- Protect Testomat 2000® DUO against interference voltages – e.g. via a mains filter.
- Shield the instrument against strong electromagnetic fields.

## Block diagram Testomat 2000® DUO

Drawn relay positions: Instrument de-energised

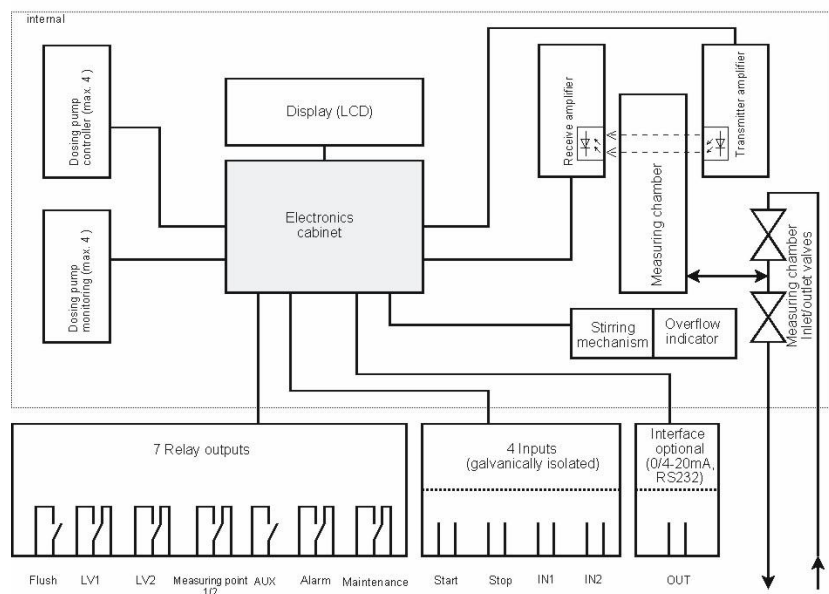

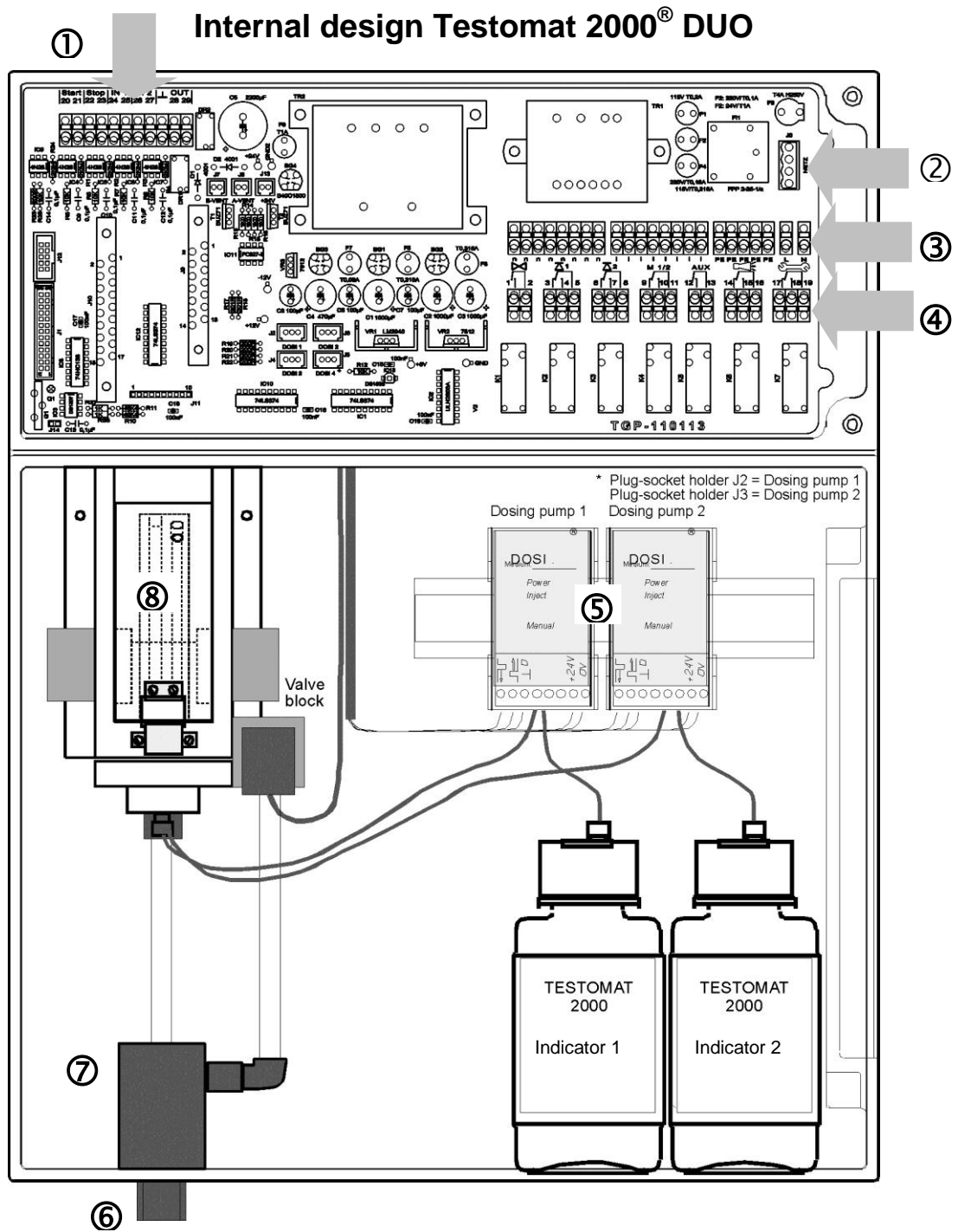

①	Terminal strip for inputs Start, Stop, IN1, IN2, and output OUT
②	Mains switch
③	Terminal strip for power input and power output
④	Terminal strip for relay outputs
⑤	Dosing pumps
⑥	Water connections, inlet and outlet
⑦	Controller / Filter receiver
⑧	Measuring chamber



### Connecting the mains voltage

Only connect the instrument to the specified mains voltage. Refer to the rating plate for the appropriate mains voltage. Connect the cables as follows:

- Loosen both fastening screws ① and open the upper door. The terminal box is now accessible.
- Pierce the required rubber cable glands ② with a screwdriver and insert the cable through the bush into the terminal box (1)
- Subsequently pull back the cable until the bush has been turned over (2)

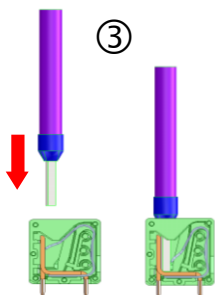
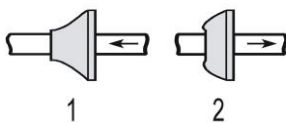

Insert the conductor with ferrule or the solid conductor into the round input.

- Connect the power supply to terminals PE,N,L or for 24 V instruments to terminals U,V
- Connect the conductor to the terminal block as shown on the left ③.
- Ensure that the leads are held securely in the terminals
- Proceed as shown in figure ④ to loosen the connection.

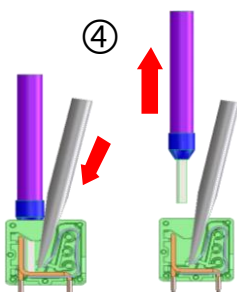

1. Insert a screwdriver into the square opening without force in order to open the terminal.
2. Once the terminal has been opened, remove the conductor.

Terminal description	Type	Function	Comment
<b>PE</b>	IN	Mains – protective earth (5x)	Only with mains 115/230 V !
<b>N (U)</b> <b>L (V)</b>	IN	Mains, N=neutral (U=24V) Mains, L=live (V=24V)	Mains input 24 V / 115 V / 230 V
<b>n</b> <b>I</b>	OUT	Neutral, switched (8x) Live, switched (8x)	Mains for consumers, max. 4 A

Connection example:  
Limit value contact LV 1  
switches mains voltage

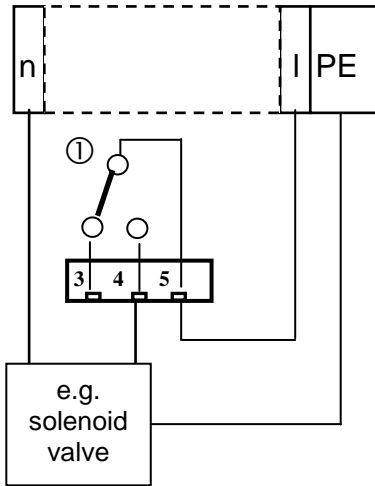

### Connecting the plant components

- Connect the plant components to the output terminals of relays 1 to 19 (e.g. valves)
- If the plant components require mains voltage, connect the switched mains voltage (I) to the common contact ① of the respective relay (see the connection example for 230 VAC on the left)
- Connect the neutral conductor of the plant component to one of the terminals (n)
- For components with a protective earth conductor connection, connect it to the PE connection
- Ensure that the leads are held securely in the terminals

No.	Terminal description	Type	Function	Comment
1 2	<b>Flush</b>	OUT	External flush valve	Isolated relay output, max. 240 VAC, 4 A
3 4 5	<b>LV1</b>	OUT	Limit value output 1 – Normally closed Limit value output 1 – Normally open Limit value output 1 – Common	Isolated relay output, max. 240 VAC, 4 A
6 7 8	<b>GW2</b>	OUT	Limit value output 1 – Normally closed Limit value output 1 – Normally open Limit value output 1 – Common	Isolated relay output, max. 240 VAC, 4 A
9 10 11	<b>Measuring points 1/2</b>	OUT	Measuring point 1 – Normally closed Measuring point 2 – Normally open Measuring point switch-over - Common	Isolated relay output, max. 240 VAC, 4 A
12 13	<b>AUX</b>	OUT	Universal output	Isolated relay output, max. 240 VAC, 4 A
14 15 16	<b>Alarm</b>	OUT	Fault message output – Normally closed Fault message output – Normally open Fault message output – Common	Isolated relay output, max. 240 VAC, 4 A
17 18 19	<b>Maintenance</b>	OUT	Maintenance message - Normally closed Maintenance message - Normally open Maintenance message - Common	Isolated relay output, max, max. 240 VAC, 4 A

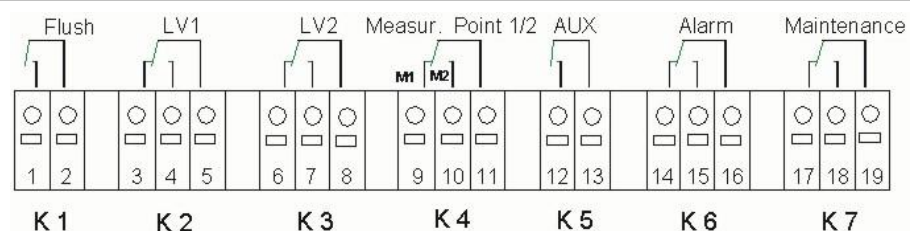

## Connecting the inputs and outputs

Testomat 2000® DUO has the following connections for control and monitoring functions.

- Do not connect external voltage to these connections!
- Ensure that the leads are held securely in the terminals.
- Use the two fastening screws to close the upper door once installation has been completed.

No.	Terminal description	Type	Function	Comment
20 21	<b>Start</b>	IN	External analysis start	Only for isolated normally open!
			Common earth for inputs	
22 23	<b>Stop</b>	IN	External analysis stop	Only for isolated normally closed/normally open!
			Common earth for inputs	
24 25	<b>IN1</b>	IN	Universal input 1	Only for isolated normally closed/normally open!
			Common earth for inputs	
26 27	<b>IN2</b>	IN	Universal input 2 (water meter)	Only for isolated normally open!
			Common earth for inputs	
⊥	<b>OUT</b>		RS 910: Earth	RS232 interface for printer
28		OUT	SK910: (+)	Galvanically separated current interface 0/4 - 20mA
		OUT	UK910: (+)	Galvanically separated voltage interface 0/2 – 10V
29		OUT	RS910: (TxD)	RS232 interface for printer
		OUT	SK910: (-)	Galvanically separated current interface 0/4 - 20mA
		OUT	UK910: (-)	Galvanically separated voltage interface 0/2 – 10V
		IN	RS232: (RxD)	RS232 interface for printer

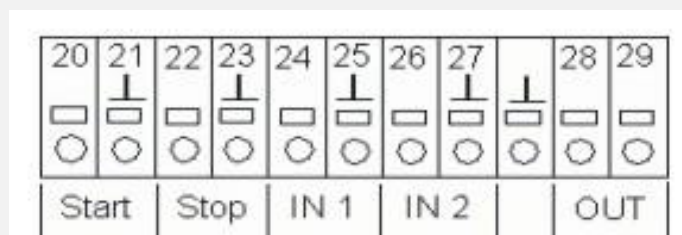

For more information, please refer to the section entitled "[Description of the signal inputs/outputs](#)".



## Commissioning



**CAUTION**

### Handling of reagents/indicators

- Adhere to the respective safety data sheet!
- Trouble-free operation of Testomat 2000® is only guaranteed when using Heyl Testomat 2000® indicators!

### Inserting the indicator bottle

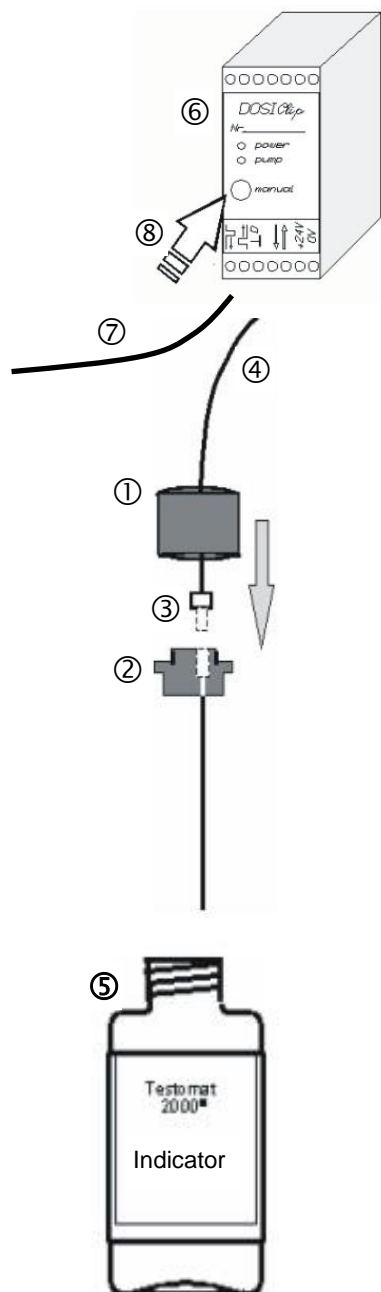

- Open the lower housing door by pulling on the right-hand side.
- Remove the cap from the indicator bottle
- Remove the plastic bag from inside the lower housing door. The plastic bag contains the screw cap with hole ① and the insert ② for the screw cap.
- Connect the parts as shown on the left.
- Screw the hose connector ③ of the intake hose ④ hand-tight into the insert ②.
- Place the insert with the screwed-in intake hose into the indicator bottle.
- Now screw the screw cap with hole ① hand-tight onto the indicator bottle ⑤.

### Extracting the indicator

- Switch the instrument on and press the "STANDBY" key.
- During operation, the pump (DOSI Clip) ⑥ automatically extracts the indicator.
- To ensure that indicator is available for the initial analyses, the intake hose ④ and the transport hose ⑦ must be filled with indicator from the pump up to the measuring chamber.
- Press the "manual" ⑧ key several times until the intake hose ④ and the transport hose ⑦ are filled with indicator up to the measuring chamber (always switch on the instrument at the mains switch first!)

### Opening the water inlet

- Open the lower housing cover.
- Slowly open the manually operated shut-off valve to prevent the measuring chamber overflowing. The flow regulator requires a few seconds to function correctly.
- Make sure that the water conducting parts are not leaky.

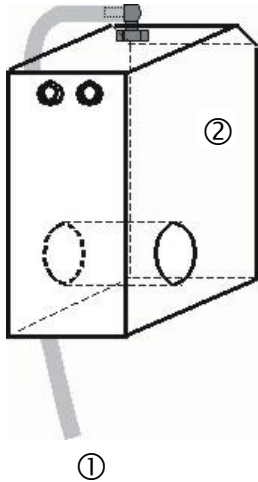

- If water sprays from the vent hole ① of the measuring chamber ②, reduce the amount of inlet water via the manually operated shut-off valve. It should take 2 to 6 seconds to fill the measuring chamber!

### Instrument settings and data input

- Please read the following information before carrying out settings and entering data for operating the instrument.

## Functions of the operating and display elements

The Testomat 2000<sup>®</sup> DUO display shows operating statuses and measured values. The input keys for programming (cursor block) and the function keys are located underneath the display.



### Switching Testomat 2000<sup>®</sup> DUO on/off

- (1) Mains switch  
Use this switch to switch the instrument on or off.
- (2) Instrument fuse (inside the instrument)  
This fuse protects Testomat 2000<sup>®</sup> DUO and the outputs against overloads and short circuits.

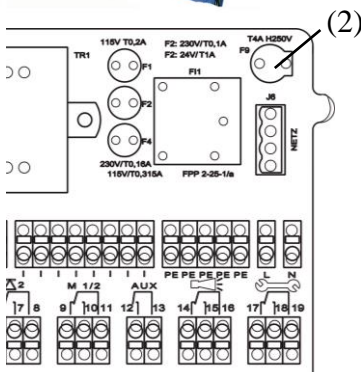

## Display functions

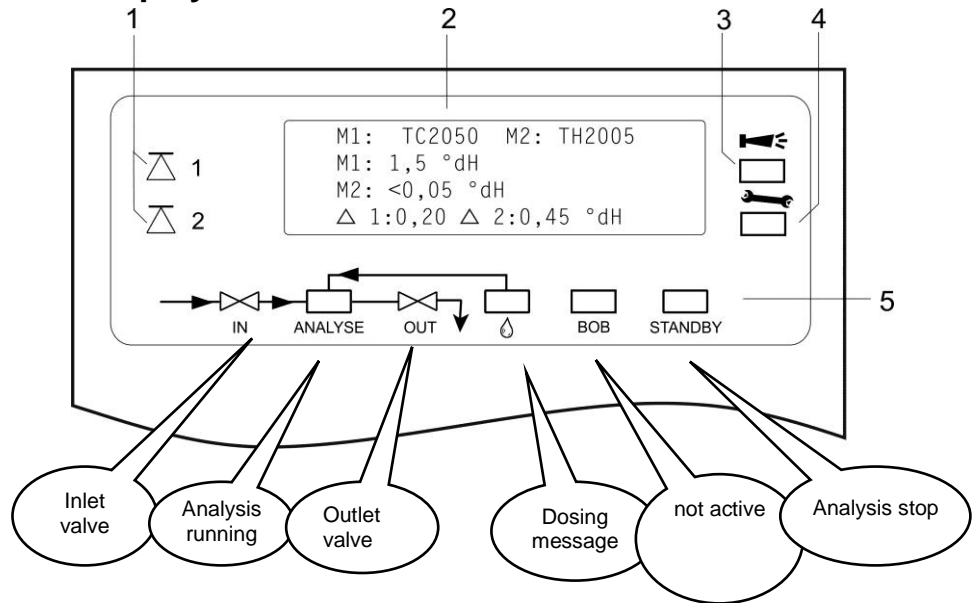

### 1 Status of limit value displays (red/green)

The display 1 illuminates red if limit value 1 has been reached or exceeded. The display 1 illuminates green if the value falls below the limit value. The same principle applies to limit value 2 and display 2.

### 2 Text display (4 lines)

Displays the current analysis result as well as all important statuses and programming data:

Line 1 = the set indicator types for measuring point 1 (M1:) and 2 (M2:) are displayed. (P1:/P2:) is displayed for a measuring point.

Line 2 = measured value display measuring point (M1) or (P1)  
Line 3 = measured value display measuring point (M2) or (P2)

Value falls below the measuring range = "<" e.g. M1: < 0.05 °dH  
Value exceeds the measuring range = ">" e.g. M1: > 5.0 °dH

Line 4 = The set limit values LV1 and LV2 are displayed

### 3 Alarm (red)

Indicates malfunctioning/error message or warning message.

### 4 Maintenance message (yellow)

Indicates current maintenance requests

### 5 Status display of the active instrument components (line)

Six displays indicate the current instrument and analysis status

All error and warning messages are alternately shown in line 1 of the standard display!



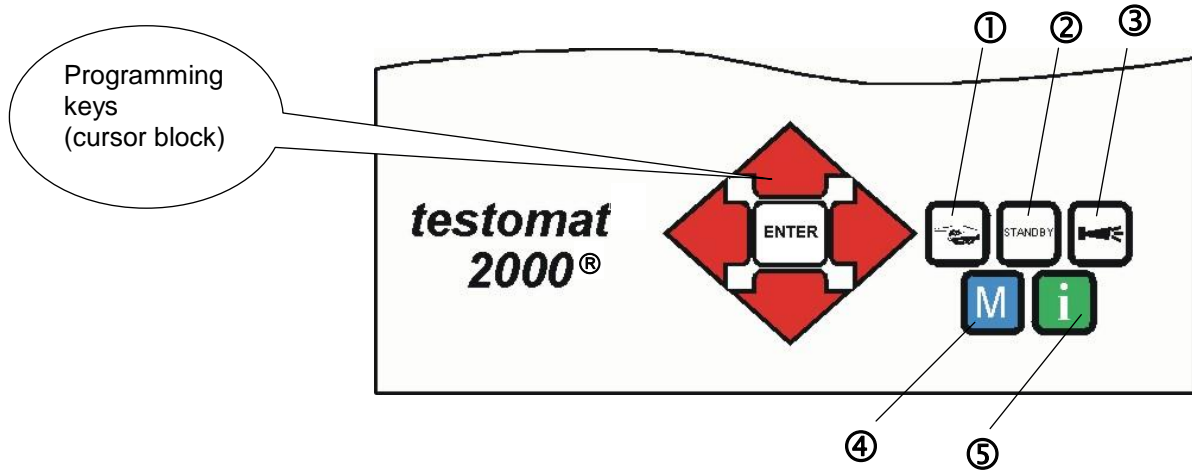

## Cancelling error messages/warning messages

- Press  to acknowledge the message and, if necessary, eliminate the cause of the fault.

## Operating elements and function keys



### Function keys

	Manually start an analysis via the " <b>Manual</b> " ① key
	Set the instrument to standby mode via the " <b>STANDBY</b> " ② key (automatic analyses are not carried out: analysis stop)
	Acknowledge error and warning messages via the " <b>Horn</b> " ③ key
	Open the program menu for user-specific and instrument-specific settings via the " <b>M</b> " ④ key
	Retrieve all instrument information and settings via the " <b>i</b> " key ⑤

**(M)enu key**



**Cursor block**



If you wish to carry out settings or enter data, or if alterations are necessary, press the "**M**" key to open the programming mode. Use this key when *in the menu* to go to the higher order menu items or to exit the programming mode. Please note: The basic program is password protected!

### Programming keys (cursor block)

Use the programming keys (cursor block) to navigate in the menu, to select the desired functions and to enter necessary instrument and plant specific data. Press the "ENTER" key to select the submenu item and to confirm and accept the selection or data input.

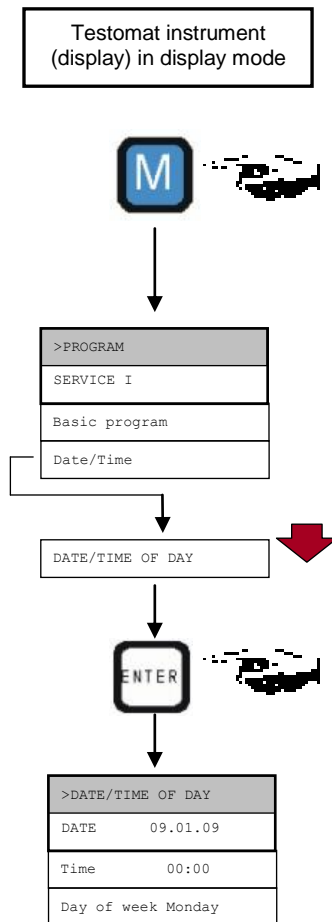

## Operating system

Instrument settings and data input

Date, time and weekday input

- Press the "M" key  
The basic menu ">PROGRAM" appears
- Use the cursor block to select the desired menu item "Date/Time"  
The selection appears in CAPITAL LETTERS.
- Press "ENTER" to confirm your selection  
The selected submenu ">DATE/TIME" appears  
The menu item "DATE" has already been selected (capital letters)
- Press "ENTER" to confirm the menu item "DATE"  
The cursor flashes in the date field: " 9.01.09"
- Use the cursor keys to select the desired number
- Use the keys to move the cursor to the next input field
- Repeat this input process until the year has been entered
- Press "ENTER" to confirm the entry  
The date has now been entered.

Exit the menu item "DATE" in order to set the time.

- Use the cursor block to select the desired menu item "TIME OF DAY"
- Press "ENTER" to confirm your selection  
The cursor flashes at the first position of the time: " 0:00"
- Use the cursor keys to select the desired number
- Use the keys to move the cursor to the next input field
- Repeat this input process until the seconds have been entered
- Press "ENTER" to confirm the entry  
The time has now been entered.

Exit the menu item "TIME OF DAY" to set the weekday

- Use the cursor block to select the desired menu item "DAY OF WEEK"
- Press "ENTER" to confirm your selection
- Use the cursor block to select the selected weekday
- Press "ENTER" to confirm the entry
- Press the "M" key twice to end programming  
The standard measured value display appears on the display

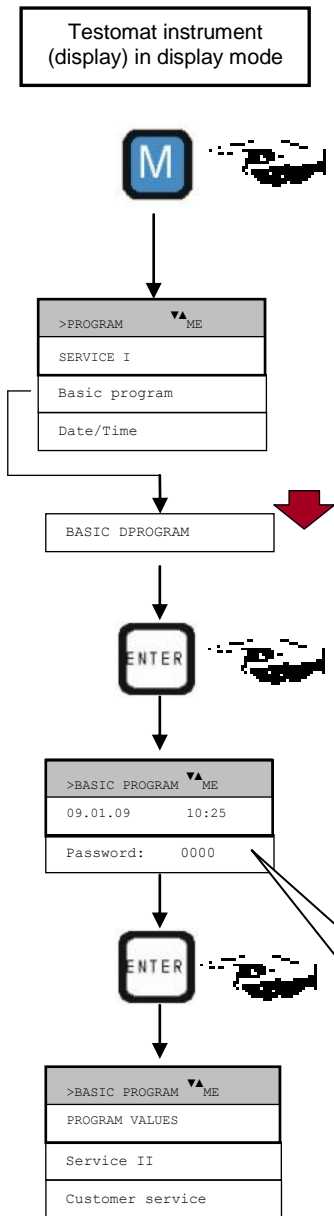

## Password protection and basic program

A four-digit password is required to enter data and to carry out settings in the basic program. The password is the current time of Testomat 2000® DUO in reverse order.

### Password entry

- Press the "M" key  
The basic menu ">PROGRAM" appears
- Use the cursor block to select the desired menu item "Basic program"  
The selection appears in CAPITAL LETTERS.
- Press "ENTER" to confirm your selection  
The selected submenu ">BASIC PROGRAM" appears
- Press "ENTER" to confirm the menu item "BASIC PROGRAM"  
The cursor flashes in the "Password:" field 0000
- Use the cursor keys to enter the time in reverse order: "5201"
- Press "ENTER" to confirm the entry

The selection menu for the basic program appears. You can now enter the plant specific data.

Geben Sie hier die Uhrzeit rückwärts ein:  
=> 5201

## Entering basic program data

### Selecting the indicator and the bottle size

- In >BASIC PROGRAM menu, select  
=> PROGRAM VALUES=> INDICATOR TYPE
- Press "ENTER" to confirm the selection

The "INDICATOR TYPE" menu shown on the left appears

>INDICATOR TYPE	ME
500ml bottle	*
100ml bottle	
TH2005 Water hardness	*
TH2025 Water hardness	
TH2100 Water hardness	
TH2250 Water hardness	
TC2050 Carbon. hardn.	
TH2100 Carbon. hardn.	
TM2005 minus-m-value	
TP2010 p-value	
TP2100 p-value	

- Select the size of the indicator bottle   
(A 500 ml bottle " \* " is factory set)
- Press "ENTER" to confirm the selection  
(An asterisk " \* " appears at the end of the line)
- Select the indicator type   
(The indicator type TH2005 " \* " is factory set)
- Press "ENTER" to confirm the selection  
(An asterisk " \* " appears at the end of the line)

The asterisk " \* " displays the active menu item.  
The indicator has now been selected.

## Selecting the operating mode

Under the menu item "Mode of Operation" it is possible to select the type of analysis controller. Testomat 2000® DUO provides numerous selection options: Time control, quantity control via water meter, dynamic analysis triggering and external analysis triggering.

**Time control**  
Internal start via timer.

Shortest interval = 0 minutes between analyses. Largest interval = 99 minutes.

The analysis interval (time between two analyses) is determined by the duration of the supplementary program AUX, the set flush times (internal and external), the programmed interval and the duration of the analysis. The analysis duration depends **directly** on the measured value.

>MODE OF OPERATION▼▲ ME	
TIME CONTROLLED	*
Volume interval	
Dynamics	
External (Start)	

### Selecting the time control

- In >BASIC PROGRAM menu, **select**  
=> PROGRAM VALUES=> MODE OF OPERATION=> TIME CONTROLLED
- Press "ENTER" to confirm the selection  
(An asterisk " \* " appears at the end of the line)  
("TIME CONTROLLED" " \* " is preset)

>FLUSH TIMES/INTERVAL ▼▲ ME	
INTERNAL FLUSH TIME	00s
External flush time	00s
Interval pause	01m

Enter the interval pause and the flush times

- In >BASIC PROGRAM menu, **select**  
=> PROGRAM VALUES=> FLUSH TIMES/INTERVAL  
=> INTERVAL PAUSE
- Enter the "INTERVAL PAUSE" in minutes (m)  
(1 minute is preset)
- Enter the "INTERNAL FLUSH TIME" in seconds (s)  
(00 seconds (s) is preset)
- Enter the "EXTERNAL FLUSH TIME" in seconds (s)  
(00 seconds (s) is preset)
- Press "ENTER" to complete all the entries

**NOTE**

### Duration of the analysis interval

- The analysis interval is the addition of the "AUX before/after analysis", "Internal flush" and "External flush" times and the measuring value dependent analysis duration (see diagram on the left)

**Analysis interval**  
Sequence of times

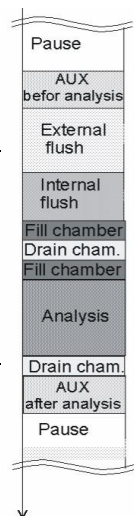

### Quantity control

Start via water meter

>VOLUME INTERVAL ▼▲ ME
00001

>TYPE OF WATER METER▼▲ ME
1 LITRE/IMPULSE
2,5 Litres/Impulse
5 Litres/Impulse
10 Litres/Impulse
100 Litres/Impulse *
500 Litres/Impulse
1000 Litres/Impulse

### External Analysis start

Start via input "Start"

>DISPLAYED UNIT1 ▼▲ ME
DISPLAY IN °dH *
Display in °f
Display in ppm CaCO <sub>3</sub>
Display in mmol/l

>MEASURING POINTS ▼▲ ME
1 Measuring point *
2 Measuring points

Minimum interval = 1 litre, maximum interval = 9999 litres. The analysis is carried out once the programmed water quantity has been measured. The line and the measuring chamber are flushed prior to the analysis (observe the programmed flush times).

#### Selecting the quantity control

- In >BASIC PROGRAM menu, select  
=> PROGRAM VALUES=> MODE OF OPERATION=> QUANTITY INTERVAL
  - Press "ENTER" to confirm the selection
- The menu on the left appears.
- Enter the respective flow rate in litres
  - Press "ENTER" to confirm the entry

#### Selecting the type of water meter

- Select the >BASIC PROGRAM menu  
=> PROGRAM VALUES=> WATER METER=> TYE OF WATER METER
- Select the water meter constant (litre/impulse)  
(100 litres/impulse " \* " is factory set)
- Press "ENTER" to confirm the selection

#### External analysis start

See section "Description of the signal inputs/outputs".

#### Selecting the display unit(s)

It is possible to program the units of the displayed values. The units dH, °f, ppm CaCO<sub>3</sub> and mmol/l can be selected. All the following inputs and displays will then be displayed in the programmed unit.

- In >BASIC PROGRAM menu, select  
=> PROGRAM VALUES=> DISPLAY UNIT1 or 2
- Select the desired unit
- Press "ENTER" to confirm the selection

#### Measuring point or parameter selection

By selecting "1 measuring point" in the menu, parameter 1 and parameter 2 are measured alternately at a measuring point (e.g. water hardness and carbonate hardness). "P" appears on the display. By selecting "2 measuring points", parameter 1 and parameter 2 are measured alternately at measuring point 1 and measuring point 2 respectively. "M" appears on the display.

The measurement can be limited to one measuring point or parameter via the input IN1. See section "Description of the signal inputs/outputs". A change-over of the parameters or measuring points also only occurs after completion of the "Hysteresis" function.



## Entering further basic program data

For selecting and entering data for these functions, please proceed as described under "Entering basic program data".

### Internal flushing

To ensure that the analysed sample represents the current value, the sampling line must be sufficiently flushed. If the plant has been out of operation for a longer period or in case of long analysis intervals, we recommend you to select a flushing time greater than 60 seconds. Flushing starts by simultaneously opening the inlet and the outlet valve of Testomat 2000® DUO.

#### NOTE

>FLUSH TIMES/INTERVAL ▼▲ ME	
INTERNAL FLUSH TIME	00s
External flush time	00s
Interval pause	01m

#### NOTE

#### Duration of the analysis interval

- The analysis interval depends directly on the programmed flushing time. If, e.g., a flushing time of 90 seconds has been set, the actual analysis interval cannot be less than 90 seconds.

- In >BASIC PROGRAM menu, select  
=> PROGRAM VALUES=> FLUSH TIMES/INTERVAL
- Enter the "FLUSH TIME/INTERNAL" in seconds (s)
- Press "ENTER" to confirm the entry

#### Setting the internal flushing time

- For connections longer than 3 m and with an internal hose diameter of 6 mm a minimum internal flushing time of 10 seconds is required to ensure that a valid sample is taken from the sampling line. The required quantity of flush water for one-minute internal flushing is 0.5 litres.

### External flushing

If very short analysis intervals are required, or if a very long (several metres) sampling line or a line with a large diameter is used, an external flush valve should be installed upstream of Testomat 2000® DUO. The external flush valve has to be connected to the "Flush" outlet. If the unit is used for monitoring two measuring points, external flushing prevents incorrect measurements caused by sample mixing. The external flushing time for the valve depends, just as the flushing time for unit flushing does, on the length and diameter of the supply line to Testomat 2000® DUO.

>FLUSH TIMES/INTERVAL ▼▲ ME	
INTERNAL FLUSH TIME	00s
Extern flush time	00s
Interval pause	01m

- In >BASIC PROGRAM menu, select  
=> PROGRAM VALUES=> FLUSH TIMES/INTERVAL
- Enter the "FLUSH TIME/EXTERNAL" in seconds (s)
- Press "ENTER" to confirm the entry

## Interval pause

If the analysis is triggered via a timer, the interval between two analyses (plus flushing time) is determined by the interval pause. The shortest interval can be 0 minutes. In this case, analyses are carried out continuously. The longest interval is 99 minutes.

>FLUSH TIMES/INTERVAL ▼▲ ME	
INTERNAL FLUSH TIME	00s
External flush time	00s
Interval pause	01m

- In >BASIC PROGRAM menu, **select**  
=> PROGRAM VALUES=> FLUSH TIMES/INTERVAL
- Enter the "INTERVAL PAUSE" in minutes (m)
- Press "ENTER" to confirm the entry

## Limit value monitoring

It is possible to program the limit values on a continuous scale. The limit value range depends on the used indicator type and the programmed unit. Two limit value outputs are available for monitoring. This ensures that two limit values or two measuring points can be monitored. The functions of the allocated relay outputs can be programmed independently of each other.

Monitoring of two limit values

If the unit is used for monitoring two *limit values*, the limit value outputs are permanently allocated to these limit values!

 1 LV1 = Limit value 1       2 LV2 = Limit value 2

Monitoring of two measuring points

If the unit is used for monitoring two *measuring points*, the limit value outputs are permanently allocated to these measuring points!

 1 LV1 = Measuring point 1       2 LV2 = Measuring point 2

If the limit value LV1 has been exceeded, the limit value control display  1 lights up RED and the relay output LV1 reacts as programmed in the switch function. If the limit value has not been exceeded, the display lights up GREEN. The same applies for the limit value LV2.

>LIMIT VALUES ▼▲ ME	
LIMIT VAL. 1:	0,25°dH
Limit val. 2:	0,15°dH

- In >BASIC PROGRAM menu, **select**  
=> PROGRAM VALUES=> LIMIT VALUES
- Enter the values for "LIMIT VALUE 1" or "LIMIT VALUE 2"
- Press "ENTER" to confirm the entry

Suppression of bad analyses

## Hysteresis

The respective limit value output only switches after the first, second or third bad analysis (suppression of the first or the second measured value). This increases the reliability of the analysis evaluation, e.g. after the measuring point has been switched over or if the sampling line has not been flushed sufficiently. The hystereses of the two outputs LV1 and LV2 can be set independently of each other.

Function: A further analysis is carried out immediately after the limit value has been exceeded for a hysteresis of 2. The respective output only reacts if the limit value of this analysis is exceeded again. If a hysteresis of 3 has been set, the respective output only reacts after the limit value has been exceeded for the third time in succession. This setting is only reactivated once the value has fallen below the limit value!

(The basic setting for LV1 and LV2 is 1)

>HYSTERESIS LV1 ▼▲ ME	
ANALYSIS (1,2,3)	1

>HYSTERESIS LV2 ▼▲ ME	
ANALYSIS (1,2,3)	1

- In >BASIC PROGRAM menu, **select**  
=> PROGRAM VALUES=> HYSTERESIS LV1 or HYSTERESIS LV2
- Enter the number of analyses
- Press "ENTER" to confirm the entry

### NOTE

#### Hysteresis and measuring point or parameter change-over

- The number of analyses entered in the menu item "Hysteresis" is always executed with the same parameter or always at the same measuring point. The parameter or measuring point change-over only occurs after completion of the Hysteresis function.

## Switch functions of the limit value outputs LV1 and LV2

Switch functions diagram

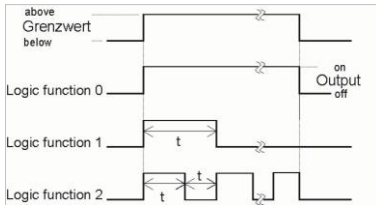

>FUNCTION LV1 ▼▲ ME	
DURATION	*
Impulse	
Interval	
Time	00m:10s

### Switch function 0, duration

If the limit value LV1 or LV2 has been exceeded, the output relay LV1 or LV2 switches. If the measured value falls below the limit value LV1 or LV2 without locking, the relevant relay drops out again.

### Switch function 1, impulse

If the measured value exceeds the limit value LV1 or LV2, the relevant output switches for a settable time (t).

The respective output always remains switched for the set time, irrespective of how long the limit value has been exceeded. A new impulse is only possible once the value has fallen below the limit value!

### Switch function 2, interval

If the limit value has been exceeded, the respective output switches at intervals with the settable time (t) = impulse or interval as long as the limit value is exceeded.

## Function IN1

This input is used to suppress change-over of the parameters or the measuring points. The measurement only occurs at parameter 1 or at measuring point 1 with parameter 1.

See section "Description of the signal inputs/outputs".

>FUNCTION IN1 ▼▲ ME	
NORMALLY OPEN CONTACT *	
Normally closed contact	

- In >BASIC PROGRAM menu, select  
=> PROGRAM VALUES=> FUNCTION IN1
- Select a normally closed or normally open contact
- Press "ENTER" to confirm the entry

>TYP OF WATER METER ▼▲ ME	
1 LITRE/IMPULSE	
2,5 Litres/Impulse	
5 Litres/Impulse	
10 Litres/Impulse	
100 Litres/Impulse *	
500 Litres/Impulse	
1000 Litres/Impulse	

## Water meter

It is necessary to connect a water meter to **input IN2** for quantity-dependent analysis triggering. Program the corresponding water meter rating.

- In >BASIC PROGRAM menu, select  
=> PROGRAM VALUES=> WATER METER
- Select the water meter rating
- Press "ENTER" to confirm the entry

## Alarm / Message

The instrument is equipped with an alarm relay output for signalling faults. The events which mean a fault at the instrument or are intended to trigger a message, can either trigger an alarm "A" (continuous contact) or a message "M" (2-second impulse).

The faults are recorded and stored in the error history if the event has been programmed as an alarm or message. For example, if a low indicator level has not been programmed as an ALARM/MESSAGE, it is not registered in the error history. Up to 20 error messages can be stored. A list of these errors can be opened in the information menu. The information stored per event is the time (day, month, year and hour) and the type of the error.

>ALARM/MESSAGE ▼▲ ME	
REAGENT LOW LEVEL A	A/M/-
Low water pressure A	A/M/-
Mf. turbid A	A/M
Ff. optics A	A/M
Ff. dosing pump A	A/M
Ff. outlet to drain M	A/M/-
Mf. dirtiness A	A/M/-
Power failure 24V M	A/M/-
Meas. range exceeded M	A/M/-
Transfer error M	A/M/-
Maint. int. exceeded M	A/M/-

A=Alarm, M=Message  
 - = no action  
 Ff.=Function fault  
 Mf.=Measuring fault

**NOTE**

- In >BASIC PROGRAM menu, select  
 => PROGRAM VALUES=> ALARM/MESSAGE
- Select the type of monitoring A=alarm, M=message or - = no action for the individual menu items
- Press "ENTER" to confirm the respective entry

### Error messages

- All error messages are lost after a power failure.
- Certain instrument faults always trigger an alarm or a message!

## Function AUX

The AUX relay output can be programmed for the following control functions:

- As a function output for the contact with programmable duration prior to and/or during the analysis, or after an analysis.

For example, it is possible to control the cooling water inlet of an upstream cooler via a solenoid valve. This ensures that the cooling water only flows when required, i.e. when an analysis is being carried out.

>FUNCTION AUX ▼▲ ME	
CONTACT BEFOR ANALYS. *	
Contact during analysis	
Contact after analysis	
Time:	00m:10s

- In >BASIC PROGRAM menu, select  
 => PROGRAM VALUES=> FUNCTION AUX
- Select the program step at which the AUX contact is to be activated
- Under "Time" enter the contact duration in minutes (m) and seconds (s)
- Press "ENTER" to confirm the entry

>SERVICE II    ▼▲ ME
RESET OPERATING TIME
Maintenance interval

## Service II

The service II menu contains various functions for monitoring the operation of the instrument:

Programming of the maintenance interval, operation (reset) internal data/setting, e.g. operating time.

### NOTE

#### Use of the Service II menu

The functions in the Service II menu directly influence the operation and monitoring functions of the instrument and can result in plant malfunctioning!

- These tasks should only be carried out by trained and qualified staff.

#### Reset operating time

After replacing a dosing pump or the measuring chamber holder, it is possible to reset the current operating time to 0 hours:

>OPERATING TIME    ▼▲ ME
000023h
Reset

- In >BASIC PROGRAM menu, **select**  
=> SERVICE II=> RESET OPERATING TIME
- Select "Reset" to reset the operating time
- Press "ENTER" to confirm the selection

The operating time "000000h" appears on the display

>MAINTENANCE INTERVAL ▼▲ ME
000D

#### Maintenance interval

Observance of the maintenance intervals is monitored and displayed by Testomat 2000®. Program the desired maintenance interval in days here. (0 days equals no maintenance interval)

- In >BASIC PROGRAM menu, **select**  
=> SERVICE II=> MAINTENANCE INTERVAL
- Enter the maintenance interval in days (D)
- Press "ENTER" to confirm the entry

>SERVICE II    ▼▲ ME
RESET OPERATING TIME
Maintenance interval

## Description of the signal inputs/outputs

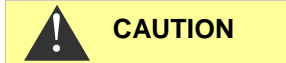

### Connecting the signal inputs

- Only connect the signal inputs "Start", "Stop", "IN1" and "IN2" with *volt-free contacts*!

The connection of external voltages would damage the instrument!

**Start**  
Terminals 20,21

Function	Test time	Action
<b>Start</b> External analysis triggering (only normally open)	None	In EXTERNAL operating mode, an analysis is started by triggering a contact at the input.  Permanent contact results in regular analyses.

**Stop**  
Terminals 22,23

Function	Test time	Action
<b>Stop</b> External analysis stop (e.g. via flow controller or process controller)	None	As long as the contact at the input is 'open' or 'closed', no analyses are carried out

An active Stop input prevents an analysis start, e.g. via a current interval. This can be necessary if the plant does not supply water. A current analysis is stopped when the input valve is opened (while the measuring chamber is being flushed or filled). The water which has already entered the measuring chamber remains there. If the measuring chamber is already full, the analysis is executed. Manual start has priority over the Stop input, i.e. if the Stop input is active, an analysis can be started manually or a manually started analysis cannot be stopped by the stop signal. In the operating mode "time-controlled", the interval time continues when the Stop input has been activated.

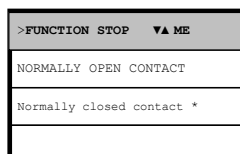

- In >BASIC PROGRAM menu, **select**  
=> PROGRAM VALUE=> FUNCTION STOP
- Select the type of contact
- Press "ENTER" to confirm the selection

## IN1

Terminals 24,25

>FUNCTION IN1 ▼▲ ME
NORMALLY OPEN CONTACT
Normally closed contact *

Function	Test time	Action
<b>IN1</b> - Measurement limited to parameter 1 or measuring point 1	Fixed, 10 seconds	<b>Selection "1 measuring point":</b> Only parameter 1 is measured as long as the contact is open or closed.  <b>Selection "2 measuring point":</b> Only measuring point 1 with parameter 1 is measured as long as the contact is open or closed.

- In >BASIC PROGRAM menu, **select**  
=> PROGRAM VALUE=> FUNCTION IN1
- Select the type of contact
- Press "ENTER" to confirm the selection

## IN2

Terminals 26,27

Function	Test time	Action
<b>IN2</b> Water meter input	None	Quantity recording for starting an analysis

## OUT

Terminals 1, 28,29

Function	Connection	Action
<b>OUT</b> Programmable interface 0-20 mA or 4-20 mA	max. load 500 Ohms	
OR Programmable voltage interface 0 - 10 V or 2 - 10 V		
OR Serial interface RS 232	Serial bus (2-wire cable)	See description of interface card RS 910 (See Technical info "T2000-RS232")
The section "Interfaces" contains a detailed description		

## Interfaces (optional)

Current interface 0/4-20 mA

### NOTE

#### Current interface load

- The maximum load of 500 Ohms should not be exceeded!  
In case of possible faults and when using very long cables (approx. 20 m), a screened cable should be used, if possible.



## Installing the interface cards SK910/RS910



Avoid static charges during installation!

Personnel responsible for installation must be appropriately trained and qualified!

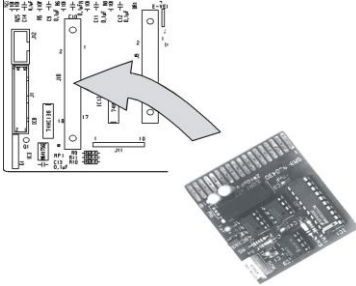

Switch off the instrument.

Insert the plug-in circuit board into the left-hand slot with the component side on the left. (Contact no.1 is at the top)

Switch on Testomat 2000®.

Program the desired type of current (0/4-20mA) (for SK910).

Example Reagent TH 2100,  
1 Measuring point, Interface 0 - 20 mA

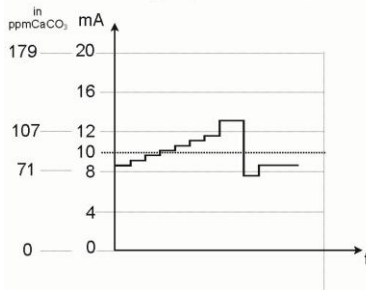

>INTERFACES ▼▲ ME	
TYPE 0-20mA	*
Type 4-20mA	
Type RS232	
Type Data logger	

>MEASURING POINTS ▼▲ ME	
1 MEASURING POINT	*
2 Measuring points	

### Monitoring a measuring point

A printer can be connected to record the analysis results. The instrument is equipped with a programmable current output for this purpose (optional 0-20 mA or 4-20 mA).

The example on the left displays the current profile in the 0-20 mA range for one measuring point.

- In >BASIC PROGRAM menu, select  
=> PROGRAM VALUE=> INTERFACES
- Select the desired current range
- Press "ENTER" to confirm the selection
  
- In >BASIC PROGRAM menu, select  
=> PROGRAM VALUE=> MEASURING POINTS
- Select the desired configuration
- Press "ENTER" to confirm the selection

### Monitoring of two measuring points

Example Reagent TH 2100,  
2 Measuring points, Interface 4 - 20 mA

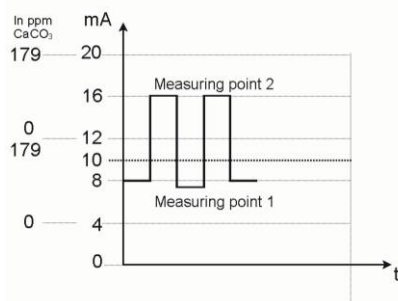

>INTERFACES ▼▲ ME	
Type 0-20mA	
TYPE 4-20mA	*
Type RS232	
Type Data logger	

The example on the left displays the current profile for 4-20mA and the use of two measuring points.

Measuring point 1 and measuring point 2 are measured alternatively. The measured value 1 is shown in display line 2 (M1:) and the measured value 2 in line 3 (M2:). . The currently analysed measuring point is indicated by an asterisk on the right.

The range of the current interface is divided. The range 4 – 12 mA is available for the measured value from measuring point 1 and range 12 – 20 mA for the measured value from measuring point 2.

- In >BASIC PROGRAM menu, select  
=> PROGRAM VALUE=> INTERFACES
- Select the desired current range
- Press "ENTER" to confirm the selection

>MEASURING POINTS ▼▲ ME
1 MEASURING POINT
2 Measuring points *

- In >BASIC PROGRAM menu, **select**  
=> PROGRAM VALUE=> MEASURING POINTS
- Select the desired configuration
- Press "ENTER" to confirm the selection

How is the current calculated for a certain measured value?

1 measuring point  
0 - 20 mA

$$\text{Current} = \frac{\text{Measured value}}{\text{Maximum value}} \times 20 \text{ mA}$$

1 measuring point  
4 - 20 mA

$$\text{Current} = \frac{\text{Measured value}}{\text{Maximum value}} \times 16 \text{ mA} + 4 \text{ mA}$$

2 measuring points  
0 - 20 mA

$$\begin{aligned} \text{Current 1} &= \frac{\text{Measured value 1}}{\text{Maximum value}} \times 10 \text{ mA} \\ \text{Current 2} &= \frac{\text{Measured value 2}}{\text{Maximum value}} \times 10 \text{ mA} + 10 \text{ mA} \end{aligned}$$

2 measuring points  
4 - 20 mA

$$\begin{aligned} \text{Current 1} &= \frac{\text{Measured value 1}}{\text{Maximum value}} \times 8 \text{ mA} + 4 \text{ mA} \\ \text{Current 2} &= \frac{\text{Measured value 2}}{\text{Maximum value}} \times 8 \text{ mA} + 12 \text{ mA} \end{aligned}$$

Measuring range not reached (e.g. <0.05 °dH)

The current is set to 0 or 4 mA. (for one measuring point)

Measuring range exceeded (e.g. >0.5 °dH)

The current is set to 20 mA.

Measured value = Value displayed in the selected hardness unit  
Maximum value = Final value of the used indicator  
(e.g. indicator type 2005 = 0.5 °dH)

## Serial interface RS232

Testomat 2000® DUO can also be connected to a log printer via the serial interface RS232 to enable the printout of measuring results and error messages. Analyses can then be continuously logged. This option is only possible in connection with the interface card RS232 (Art. no. 270310).

>INTERFACES ▼▲ ME
Type 0-20mA
Type 4-20mA
TYPE RS232 *
Type Data logger

- In >BASIC PROGRAM menu, **select**  
=> PROGRAM VALUES=> INTERFACES

- Select the desired interface
- Press "ENTER" to confirm the selection

## SD card data logger

With the SD card data logger (article number 100490), the measurements of the Testomat 2000® can be logged continuously.

To operate the data logger, please proceed as follows:

>INTERFACES	▼▲ ME
Type 0-20mA	
Type 4-20mA	
Type RS232	
TYPE DATA LOGGER *	

- In >BASIC PROGRAM, select
  - => PROGRAM VALUES=> INTERFACES
- Select Type Data logger.
- Press "ENTER" to confirm the selection

## Description of the relay outputs

All relay outputs are neutral contacts. This ensures that all connection options are available. The switching of mains voltage and external voltage, and the direct switching of inputs, e.g. a process controller, can be realised.

**Flush valve**  
Terminals 1,2

### Flushing (external flush valve)

Immediately before each analysis the external flush valve is opened for the programmed period allowing the line up to Testomat 2000® DUO to fill with measuring water. Please ensure that the programmed flush time is sufficient.

Please refer to ""[External flush](#)"" for programming details

### LV1 and LV2 limit value outputs

Two volt-free relay contacts are available to signal that a limit value has been exceeded. The limit values, the hysteresis and the function can be freely programmed for both contacts:

**Limit value 1**  
Terminals 3,4,5

Function	Contact	Action
<b>LV1</b> Relay switches if limit value 1 or measuring point 1 have been exceeded	Volt-free change-over contact	programmable: - Continuous contact - Impulse (1 - 99 seconds/minutes) - Interval (1 - 99 seconds/minutes) - Hysteresis (1, 2 or 3 limit values exceeded)

**Limit value 2**  
Terminals 6,7,8

Function	Contact	Action
<b>LV2</b> Relay switches if limit value 1 or measuring point 2 have been exceeded	Volt-free change-over contact	programmable: - Continuous contact - Impulse (1 - 99 seconds/minutes) - Interval (1 - 99 seconds/minutes) - Hysteresis (1, 2 or 3 limit values exceeded)

For a detailed description and programming refer to the section entitled "[Switch functions of the limit value outputs LV1 and LV2](#)"!

### Measuring points 1 or 2 (measuring point switch-over)

**Measuring point switch-over**  
Terminals 9,10,11

The Testomat 2000<sup>®</sup> DUO can be used to monitor two measuring points. Two external valves that can be controlled via the terminals 9, 10, 11 are required for this task. The menu item "2 measuring points" must be selected for this option.

Measuring point switch-over occurs automatically alternating with the analyses. The parameters are strictly allocated to the measuring points:

Measuring point 1 = Parameter 1 (indicator type 1)

Measuring point 2 = Parameter 2 (indicator type 2)

>MEASURING POINTS ▼▲ ME	
1	MEASURING POINT
2	Measuring points *

- In >BASIC PROGRAM menu, **select**  
=> PROGRAM VALUES=> MEASURING POINTS
- Select "2 measuring points"
- Press "ENTER" to confirm the selection

Measuring point switch-over can be suppressed by a contact (or normally closed contact) at input IN1. The active status of IN1 has to be programmed accordingly.

IN1 active = Measurements only from measuring point 1

A switch-over of the measuring points also only occurs after completion of the "Hysteresis" function.

## AUX

Terminals 12,13

>FUNCTION AUX	▼▲ ME
CONTACT BEFOR ANALYSIS *	
Contact during analysis	
Contact after analysis	
Time:	00m:10s

### AUX (Programmable function output)

The functioning of this volt-free relay output is programmable:

1. For reporting a current analysis and/or
2. For contact prior to an analysis, e.g. to operate a cooler or
3. Contact after an analysis

- In >BASIC PROGRAM menu, **select**  
=> PROGRAM VALUES=> FUNCTION AUX
- Select the program step at which the AUX contact is to be activated
- Under "Time" enter the contact duration in minutes (m) and seconds (s)
- Press "ENTER" to confirm the entry

## Alarm

Terminals 14,15,16

The following faults activate the "Alarm" output and are displayed:

### **Always** fault message for:

Power failure  
Low water level  
Function fault optics  
Measuring fault analysis  
Function fault dosing pump  
Function fault drain outlet  
Function fault failure 24V

### **Programmable** fault messages for:

Low indicator level  
Function fault dosing error  
Function fault soiling  
Measuring fault turbid  
Measuring range exceeded  
Maintenance exceeded

### Alarm (fault message output)

The "Alarm" output is a volt-free change-over relay contact. During trouble-free operation, the contact between the terminals 15 – 16 is closed and the one between terminals 14 – 16 is open. In case of a voltage breakdown, the contact between the terminals 14 – 16 is closed and the one between terminals 15 – 16 is open.

The instrument is equipped with a range of monitoring functions. You can define the individual statuses as a fault and program the corresponding message either as a continuous contact (A) or as a message impulse (M).

Functions/Behaviour of the "Alarm" output:

- With a continuous contact, the "Alarm" output remains activated (terminals 14 – 16 closed) as long as the fault persists.
- With a message impulse, the output is switched 'on' for 2 seconds and then switched 'off' for 5 seconds.
- If several faults with differently programmed messages are signalled simultaneously, the output is switched to continuous contact.
- The red LED "Alarm" and the text on the display indicate a fault.
- The fault message signal at the "Alarm" output is deleted by confirming the fault via the "Horn" key.
- The error message can only be deleted if the fault has been eliminated.
- Exception: The maintenance date has been exceeded. This message is confirmed in the M menu, see below (Maintenance).
- Each new fault is entered into the error history (also see "i menu").
- There is **no** additional alarm via the fault message output when the limit value is exceeded!

The error messages are described under "[Error messages / Troubleshooting](#)"

**Maintenance**

Terminals 17,18,19

**Activation** of the maintenance output for:

Low indicator level  
Function fault dosing error  
Function fault soiling  
Maintenance date reached

**Maintenance (output for maintenance message)**

The "Maintenance" output is a volt-free change-over contact. During trouble-free operation without a programmed maintenance interval, the contact between the terminals 17 – 19 is closed and the one between terminals 18 – 19 is open.

The instrument is equipped with a range of monitoring functions and a programmable maintenance interval. The respective maintenance message is always a continuous contact.

A maintenance request is displayed via the yellow "Maintenance" LED. The maintenance display can only be deleted once the status has been corrected or after the maintenance request has been confirmed.

Please refer to the section "[Password protection and basic programming](#)" for further programming details.



# Program menu "M"

## Service I (2)

### Input indicator (3)

Enter the new filling levels after **each** refill or indicator bottle change. Once you have selected the menu item for entering the filling level "Indicator filling (0 - 100%)" via the "ENTER" key, the value is preset to 100%. If you have connected a full bottle, press "ENTER" to confirm the value.

If the filling level of the bottle differs, enter the corresponding value.

### Manual operation (4)

After confirming the information message (4) via the "ENTER" key, it is possible to select and activate the desired function by using the arrow keys and pressing the "ENTER" key. These functions are used for checking the functions and for commissioning.

## Flush (5)

Press the "ENTER" key to start the flushing of the sampling line via the internal valves. Press the "ENTER" key again to cancel this function.

## Flush chamber (6)

Press the "ENTER" key to flush the measuring chamber once.

## Drain chamber (7)

Press the "ENTER" key to open the outlet valve in order to drain the water from the measuring chamber. Press the "ENTER" key again to cancel this function.

## Fill chamber (8)

Press the "ENTER" key to fill the measuring chamber.

Call: (1)

Use the **M** key to open the program menu "M".

It is possible to call up all the functions without password protection except for the basic program.

Programming of: Indicator, manual mode, flushing, flush chamber, drain chamber, fill chamber, self-test, confirm maintenance, diagnosis, date, time, basic program with password

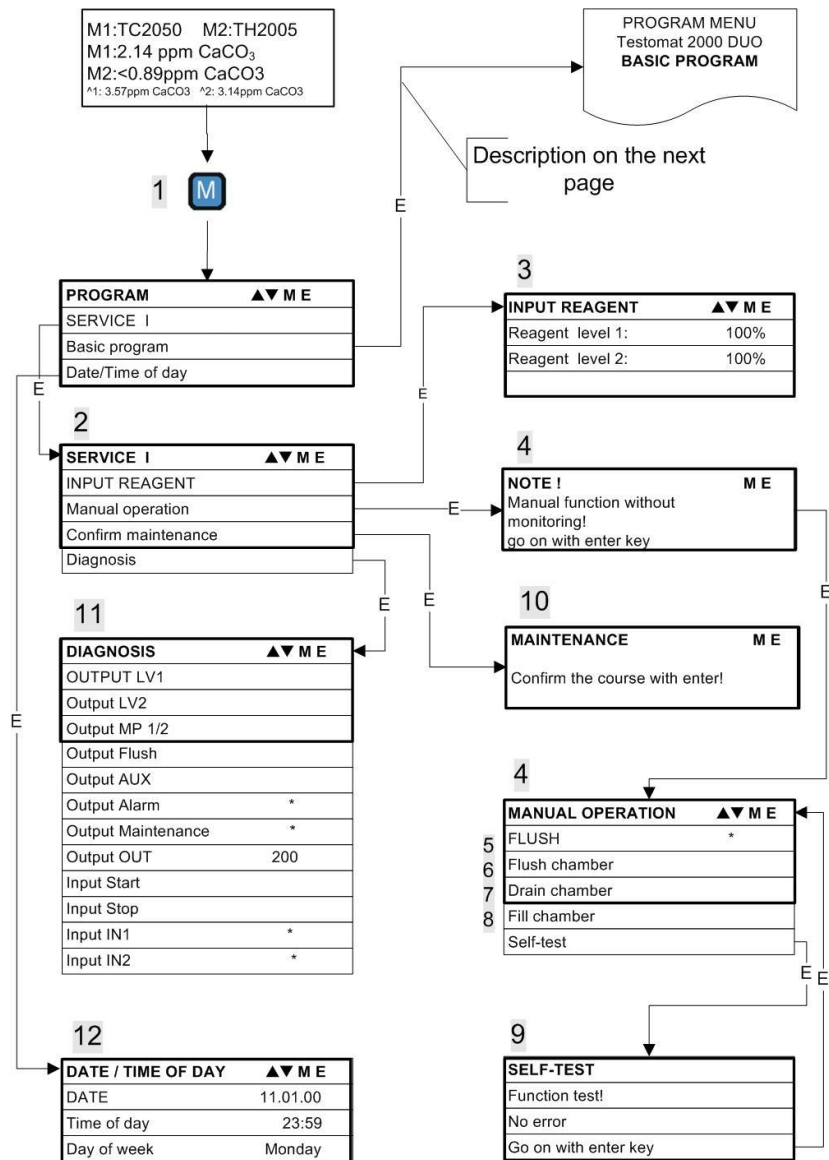

## NOTE

## Availability of functions

- All manual functions can only be selected during an analysis pause. Analyses are not carried out during manual operation. All signal inputs and outputs are locked.



>SELF-TEST	▼▲ ME
FUNCTION TEST!	
No error	
Go on with enter key	

### Self-test (9)

Press "ENTER" to start the functional test of Testomat 2000® DUO. The program checks all relevant instrument functions and carries out an analysis. A respective message appears after an error-free test. Press the "ENTER" key again to cancel this function and to return to the "MANUAL MODE" menu.

>MAINTENANCE	ME
Press ENTER to confirm the process	

### Confirm maintenance (10)

After maintenance has been carried out, confirm it by pressing the "ENTER" key and exit this item via the "M" key. The maintenance interval is restarted.

Confirm a maintenance request once the maintenance interval has expired in the M menu. The displayed message is deleted and the "maintenance" output reset.

Refer to the section entitled "[Maintenance](#)" for further details on maintenance intervals.

>DIAGNOSIS	▼▲ ME
OUTPUT LV1	
Output LV2	
Output MP. 1/2	
Output flush	
Output AUX	
Output alarm	*
Output Maintenance	*
Output OUT	200
Input start	
Input stop	
Input IN1	*
Input IN2	*

### Diagnosis (11)

It is possible to request a list of current statuses of the signal inputs and outputs. Active statuses are marked with an \*. (see "[Structure of the basic program](#)").

The current interface can be checked under "OUT output". Press the "Enter" key to toggle between minimum and maximum current. Change-over occurs between 000 and 200 at 0-20 mA!

### Time/Date (12)

Set the time and date by selecting and activating the desired function via the arrow keys and the "ENTER" key. Subsequently press the "M" key again to save the setting and to return to the display function.

Refer to "[Operating system](#)" for more details

### Call the factory default setting:

Press the "M" and "i" key and switch on Testomat 2000® DUO.

**Caution:** All previously entered data is overwritten!

The values and settings of the basic default setting are described in the "[structure of the basic program](#)".

### Basic program

This menu item can only be accessed after entering the password!

After entering the password and confirming it via the "ENTER" key, it is possible to carry out basic programming of the instrument and to select various service functions (e.g. calibration).

In the basic program, the following abbreviations are used in the respective menu items:

s = seconds; m = minutes; h = hours; T = days; l = litres



## Error messages / Troubleshooting

Displayed message (flashes at selected display)	Instrument result functions	Possible causes	Remedies
Ff. POWER FAILURE 24 V ➤ CANCEL WITH HORN KEY	- After programming: Continuous alarm or message impulses - Standby	- Internal power failure of the 24 V supply	➤ Replace fuse F4 or F8 (The control lamp "Power" of the dosing pump should illuminate)
Ff. DOSING PUMP ➤ CANCEL WITH HORN KEY	- After programming: Continuous alarm or message impulses - Standby	- Dosing pump is defective - No dosing message from dosing pump	➤ Replace dosing pump ➤ Check cable to the dosing pump for correct connection
Mf. TURBID ➤ CANCEL WITH HORN KEY	- After programming: Continuous alarm or message impulses or no message - Continue measurements	- The water is turbid / soiled	
MEASURING RANGE EXCEEDED ➤ CANCEL WITH HORN KEY	- After programming: Continuous alarm or message impulses or no message - Continue measurements	- The measuring range has been exceeded	➤ Select another type of indicator (basic program)
LOW WATER LEVEL ➤ CANCEL WITH HORN KEY	- After programming: Continuous alarm or message impulses - Standby	- no water input although LED "IN" lights up - Inlet pressure too low - Overflow detection does not react	➤ Check water inlet ➤ Connector at the inlet valve oxidised ➤ Clean filter strainer ➤ Replace valve block Extract pressure controller valve body ➤ Replace fuse F6
Ff. OUTLET TO DRAIN ➤ CANCEL WITH HORN KEY	- After programming: Continuous alarm or message impulses - Standby	- Water remains in the measuring chamber although LED "OUT" illuminates	➤ Check water outlet ➤ Connector at the outlet valve oxidised ➤ Replace valve block
LOW INDICATOR LEVEL ➤ CANCEL WITH HORN KEY	- After programming: Continuous alarm or message impulses or no message - LED and output "maintenance" on - Continue measurements	- Minimum indicator quantity not reached Without BOB: 50 ml (10%), With BOB: According to calculation	➤ Check indicator level and, if necessary, refill (enter the filling quantity!):
Mf. SOILING ➤ CANCEL WITH HORN KEY	- After programming: Continuous alarm or message impulses or no message - LED and output "maintenance" on - Continue measurements	- Sight-glass windows are soiled	➤ Clean sight-glass windows
Ff. OPTICS ➤ CANCEL WITH HORN KEY	- After programming: Continuous alarm or message impulses - Standby	- Plug-in circuit board defective - Error at the optical component (transmitter or receiver defective)	➤ Replace plug-in circuit board ➤ Measuring chamber holder

Abbreviations: Ff.: = function fault, Mf. = Measuring fault

Displayed message (flashes at selected display)	Instrument result functions	Possible causes	Remedies
Mf. ANALYSIS  ➤ CANCEL WITH HORN KEY	- After programming: Continuous alarm or message impulses - Standby	- Air inside the dosing hoses - Incomplete mixing - Indicator out of date or use of a third-party indicator	➤ Retighten connections of the dosing pump(s) ➤ Replace suction insert in the bottle(s) ➤ Replace stirring bar ➤ Replace indicator, only use HEYL Testomat 2000® indicator
Ff. DOSING ERROR  ➤ CANCEL WITH HORN KEY	- After programming: Continuous alarm or message impulses or no message - LED and output "maintenance" on - Continue measurements	- Dosing accuracy of the dosing pump	➤ Replacing dosing pump or return for calibrating
MAINTENANCE INTERVAL EXCEEDED BY XXX DAYS  ➤ CANCEL WITH HORN KEY	- After programming: Continuous alarm or message impulses or no message - LED and output "maintenance" on - Continue measurements	- Programmed maintenance date reached or exceeded	➤ Carry out maintenance and subsequently cancel or confirm
Abbreviations: Ff.: = function fault, Mf. = Measuring fault			

## Further information

Error	Possible causes	Remedies
Current interface functions incorrectly	- Incorrect measured value at the output or no power supplied	➤ Replace fuse F7 ➤ Replace the interface circuit board
Unit is not functioning, even though it is switched on No display	- Fuse F9, F5 or F2 (240 V: F1) defective - Power switch defective - Ribbon cable at display circuit board or base circuit board is loose - Error at display circuit board or base circuit board	➤ Replace fuses ➤ Replace power switch ➤ Reconnect ribbon cable ➤ Replace display or base circuit board

### Response of a protective circuit

After a protective circuit (fuse) has been tripped, attempt to eliminate the **cause** of malfunctioning (e.g. replace a defective valve) before reactivating the protective circuit. Frequent tripping is usually due to **power overload** which, in certain circumstances, may also damage the instrument.

### Malfunctioning/Repairing a defective instrument:

The repair of a defective instrument – irrespective of the warranty period - is only possible after the instrument has been dismantled and returned to us with a description of the error. Furthermore, please inform us of the indicator type being used and the measured medium. Before you return the instrument for repair work, remove the bottle and ensure that the measuring chamber has been flushed out and is empty.

# Maintenance

## NOTE

### Required maintenance measures

- Regular maintenance is necessary to ensure trouble-free operation of the instrument!

Please regularly carry out the maintenance work described in the following section when

- the programmed maintenance date has been reached (display "maintenance date exceeded")
- the instrument displays the following error messages: "Mf. soiling" or "Low indicator level"
- the last maintenance was carried out max. 6 months ago

## CAUTION

### Cleaning measures

- Never use organic solvents to clean the measuring chamber or other plastic parts!
- Please observe the safety regulations when handling cleaning agents!
- If the measuring range of the instrument is exceeded over a longer period of time, a coloured film may form on the sight-glass windows. Use isopropanol to remove this sticky film.

## Description of maintenance work

The maintenance manual Teastomat 2000<sup>®</sup>/Testomat ECO<sup>®</sup> contains a detailed description of maintenance work. The measures described here provide a brief overview.

### Cleaning the measuring chamber and sight-glass windows

- Switch off the instrument or press the "STANDBY" key . If required, remove any water from the measuring chamber:  
**M** → SERVICE I → MANUAL OPERATION → Drain chamber
- Close the manually-operated valve of the branch line to Testomat 2000<sup>®</sup> DUO.
- Unhook the toggle type fastener a, tip the measuring chamber upwards and remove it.
- Release both sight-glass window holders b, remove and clean the sight-glass windows.
- Use isopropanol to clean off the film on the sight-glass windows. If the instrument has been used with hard water for a longer period of time (measuring range exceeded!), a hard-to-remove film may have formed on the sight-glass windows. In this case, clean the sight-glass windows as described below for cleaning the measuring chamber.

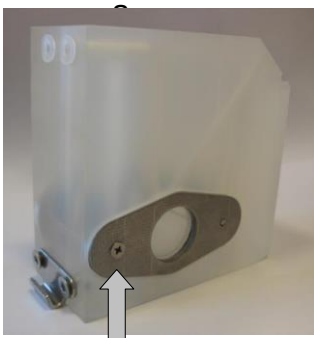
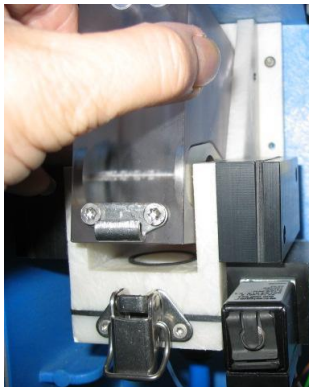

b

- The measuring chamber can be cleaned with a cleaning agent suitable for decalcification and rust removal. Flush the measuring chamber thoroughly after cleaning.
- After cleaning, re-insert the sight-glass windows and secure them with the sight-glass window holders b (do not forget the flat seals and ensure correct fitting in the groove).
- Re-insert the measuring chamber and use the toggle type fastener to secure it.



### Removal and installation of the sight glass windows

Ensure tension-free mounting of the sight glass windows. Tighten the screws equally alternating both sides. Otherwise, the sight glass windows may break.

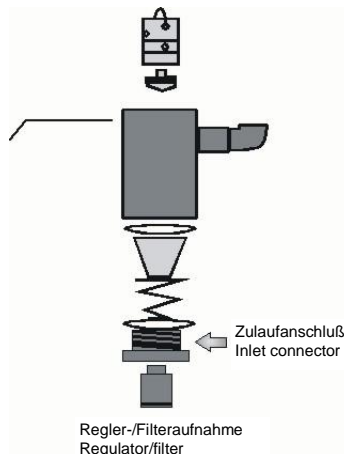

### Cleaning the filter housing

- Close the manually-operated valve of the branch line to Testomat 2000<sup>®</sup> DUO.
- Depressurise the lines of Testomat 2000<sup>®</sup> via the "Flush" function: **M** ➤ SERVICE ➤ MANUAL OPERATION ➤ Flush chamber
- Switch off the instrument and loosen the hose connections at the filter housing.
- Unscrew the inlet connection using an open ended spanner (size 22) and remove the seal, spring and filter.
- Remove the retaining pin and extract the flow controller, subsequently remove the flow controller valve body.
- Clean the filter housing with water or alcohol; then reassemble the unit.
- If required, replace the seals.
- Insert the filter strainer with the cone facing downwards!
- Re-attach the hose connections at the filter housing.

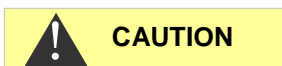

### Important maintenance information

Water leakage at sealed points can damage parts of the instrument!

Please check the instrument for leaks prior to the first analysis.

- Switch the instrument to STANDBY
- Manually fill the measuring chamber
- Manually dose the indicator ("Manual" key)

Check the connections and seals for leaks

## Service instructions

The surface of the instrument has not been treated. Therefore, avoid any soiling caused by indicators, oil or grease. However, if the housing becomes soiled, please clean the surface with isopropanol (never use other solvents).

## Testomat 2000® spare parts and accessories

Art. No.	Pressure controller
40125	Controller / Filter receiver, complete
40120	Controller / Filter receiver
40129	Controller plug T2000, complete
11225	Flow controller valve body, complete
11230	Retaining pin 3x38 90°
11217	Inlet filter 19.5dx25
11218	Spring for inlet filter
40121	Inlet connector
40153	Screw-in connector G 1/4" -6
40157	Angled plug-in connector G 1/8"
Measuring chamber	
40173	Sight-glass window with seal, T2000
40170	Sight-glass window 30x3
40176	Sight-glass holder, countersink and thread.
33253	Bolt M3x40, A2, DIN 965
40032	Latch fastener TL-17-201-52
11210	Plug for measuring chamber
40022	Measuring chamber T2000, complete
Measuring chamber holder	
40370	Measuring chamber holder, complete (without valves)
40050	Magnetic stirrer
40186	Screw-in connector 3/8" -10
40018	Solenoid valve, 2/2-way
40181	Rear guide bar for measuring chamber 5 x 60
Dosing pump DOSIClip®	
40001	Jet pump SP
40011	Suction hose, complete
40016	Pressure hose, complete
37232	Base circuit board TI (3)
40040	Valve set
32046	Plastic cover CNH 45 N
Bottle connection / Suction device	
40131	Screw cap with bottle insert T2000
40130	Screw cap GL32 - hole
40135	Bottle insert for screw cap with push-fit suction tube

Art. No.	Unit spare parts list
31582	Fuse GS-M 5x20E 4A
40294	Base circuit board T2000, complete 230V
40092	Control circuit board T2000, complete
40091	Plug in circuit board driver/receiver SE-T2000 (6)
40190	Cable sleeve 5-7, grey
40191	Cable sleeve 7-10, grey
31713	Ribbon cable 10 pole with EMI filter clamp
40096	Ribbon cable 26 pole with EMI filter clamp
40060	Cable loom 2V for T2000
40062	Cable loom 2P for T2000
40200	Cable loom complete with power switch and cover
31596	Fuse, soldered T0.16A
31585	Fuse, soldered T0.315A
31595	Fuse, soldered T0.1A
31622	Fuse, soldered T0.16A
31592	Fuse, soldered T1.016A
Spare parts requirement for 2 - 3 years of operation	
40173	Sight-glass window with seal, T2000
11217	Inlet filter 19.5dx25
40124	Gasket set T2000
31585	Fuse, soldered T0,315A
31592	Fuse, soldered T1.016A

## Accessories

Indicator type	Range	Art. no.:
TH2005	Water hardness 0.05 – 0.5 °dH	152005
TH2025	Water hardness 0.25 – 2.5 °dH	152025
TH2100	Water hardness 1.0 – 10.0 °dH	152100
TH2250	Water hardness 2.5 - 25 °dH	152250
TC2050	Carbonate hardness	153050
TC2100	Carbonate hardness	153100
TM2005	minus m-value	154005
TP2010	p-value	155010
TP2100	p-value	155100

Please refer to our delivery programme for an up-to-date overview of available accessories.

Art. no.	Description
040123	Retrofit kit for water inlet T2000 *)
040315	Discharge hopper for Testomat 2000/ECO
270305	Current interface card 0/4-20 mA, SK 910
270500	Log printer
270501	Power supply unit for log printer
270410	Booster pump
270337	Maintenance case T2000 Heyl

**\*) retrofit kit for water inlet (Art. no. 040123)**

If fabric-reinforced pressure hoses (e.g. for existing installations) are used, please replace the plug connector at the controller and filter housing with a plug for the quick-release coupling (not included).



## Technical data

Power supply:	230 VAC, 115 VAC or 24 VAC $\pm$ 10%, 50 - 60 Hz Instrument fuse 230 V: T0.1A Instrument fuse 115 V: T0.2A Instrument fuse 24 V: T1.0A
Power consumption:	max. 30 VA, without external load
Protection class:	I
Degree of protection:	IP 65
Conformity:	EN 50081-1, EN 50082-2, EN 61010-1 
Ambient temperature:	10 - 45°C
Measuring range:	See section "Performance specifications"
Current interface:	0/4 - 20 mA, max. load 500 Ohm
Protocol printer:	See section "Accessories"
Dimensions:	W x H x D = 380 x 480 x 280 mm
Weight:	Approx. 9.5 kg
Other:	The instrument is non-volatile

<b>Water connection</b>	
Operating pressure:	1 to 8 bar / $1 \times 10^5$ to $8 \times 10^5$ Pa or 0.3 to 1 bar / $0.3 \times 10^5$ to $1 \times 10^5$ Pa (Remove flow controller valve body 11225!)
Water inlet:	Opaque pressure hose with an external diameter of 6/4x1 mm
Water outlet:	Pressure hose with an internal diameter of 12 mm
Water temperature:	10 to 40 °C

\* When using Testomat 2000<sup>®</sup> at a pre-pressure of 0.3 bar, it must be ensured that the flow rate through the measuring chamber is at least 400 ml/min.

**We reserve the right to make technical changes without notice in the interest of constantly improving our products!  
Our manuals are updated regularly. If you have an older version (see version at the back of the manual) you will find the current manual on our website [www.heyl.de](http://www.heyl.de) on the download page.**

## Conformity Declaration

### EC Conformity Declaration



for the following product

#### **Testomat 2000 DUO**

**Online analysis unit for water hardness, carbonate hardness, p-value or minus m-value**

We hereby confirm that the above product conforms to the principal health and safety regulations laid down in the EC Directives 2004/108/EG and 2006/95/EG. This declaration applies to all units produced in accordance with the attached manufacturing documents which are a constituent part of this declaration.

The product was assessed with reference to the following standards:

**EN 61000-6-4:** Electromagnetic compatibility, Generic emission standard

**EN 61000-6-2:** Electromagnetic compatibility, Generic immunity standard

**EN 61010-1:** Safety requirements for electrical equipment for measurement, control and laboratory use

This declaration is made on behalf of

**GEBRÜDER HEYL**  
**Analysentechnik GmbH & Co. KG**  
**Orleansstraße 75b**  
**31135 Hildesheim**

by

  
Jörg-Tilman Heyl  
General Manager

Hildesheim, 09/01/2013

# Check List Testomat 2000®

Dear customers and service technicians,

This check list cannot replace your expertise or extensive experience in fault resolution. It is intended to support fast and systematic error diagnosis and error documentation. This list does not claim to be complete. We are therefore always grateful for any advice and information you may be able to provide. General user instructions can be found on the rear of this check list.

The Instrument Manufacturer

## Block 1 / Plant and instrument data

	Testomat 2000®				
	Testomat® ECO				
Plant type	Instrument type	Instrument no.	Indicator type	Software status	Pump no.

## Block 2 / Error message and error history

Please mark appropriately (X)

What does your instrument's error history display? (“i” and “Enter” key => operating instructions)				( Error history text )
Does an error message appear on the display? For example, “Mf. analysis”, “Low water level”, etc. (See operating instructions: “Error messages / Troubleshooting”)	Yes	No		( Error message text )

## Block 3 / Visual inspection and functional test

Please mark appropriately (X)

If applicable, values / comments

Is the instrument connected to the mains voltage specified on the rating plate?	Yes	No	
Does a message appear on the display?	Yes	No	
Does the instrument display a plausible measured value? (possible manual measurement _____ value)	Yes	No	Measured value:
Are the measuring chamber and sight-glass windows clean?	Yes	No	
Are the measuring chamber and the water-carrying hoses free of leaks?	Yes	No	
Is the indicator's expiry date still valid? (See expiry date printed on the indicator bottle)	Yes	No	Expiry date:
Has the correct indicator type been programmed? (TH 2025 => 0.25 to 2.5 °dH = factory setting)	Yes	No	Type:
Is the water pressure within the specified range (400 ml/min)? (See the type plate on the instrument)	Yes	No	Plant pressure:
Does the drain hose prevent the risk of backwater? (No “syphoning effect”!!)	Yes	No	
Is the drain hose free of blockages? (Microorganisms caused by contamination, etc.)	Yes	No	
Does the set flushing time/quantity of flush water ensure that only freshwater is measured?	Yes	No	Flushing time:
Are the hoses at the dosing pump free from air bubbles? (Operate the pump manually / Carry out a manual analysis)	Yes	No	

### CARRYING OUT A (MANUAL) ANALYSIS

Does the water column rise evenly up to the overflow borehole when filling the measuring chamber (5 mm below the upper edge of the measuring chamber)? (If not: check the water pressure, water throughput/flow controller)	Yes	No	
Does the indicator pump dose correctly when starting an analysis? (LED at the pump illuminates!)	Yes	No	No. of dosing strokes:
Have the indicator and water been mixed properly in the measuring chamber after the dosing process? Check the magnetic stirring bar! =>see maintenance manual “Adjust mode”	Yes	No	

### PROGRAMMING DATA / OPERATING CONDITIONS

Have the limit values been set correctly? (Within the measuring range/according to the performance limit of the plant?)	Yes	No	Limit values:
Is the Testomat instrument always supplied with mains voltage – except during maintenance work/emergency situations? (Temporary shutdown only via the “Standby” key or the “Stop” input!)	Yes	No	See the “General instructions for operating Testomat 2000® and Testomat® ECO”

Please refer to “Error messages / Troubleshooting” in the **operating instructions** for further information on error messages and possible causes of faults.

Further functional tests (e.g. overflow detection and amplification setting => “Special function Adjust mode”) and service instructions can be found in the **maintenance manual**.

After completing these checks, experience shows that it can be assumed that the checked functions (Block 3) are in effective working order if you have answered all the questions with “Yes”. We recommend you to carry out these checks during each inspection or if faults occur.

# Instrument settings

## Caution!

Your settings may be deleted if repairs are carried out. Therefore, note down your instrument settings in the table below before sending the instrument to our service team for repairs. Please enclose a copy of the table with the instrument. If you have noted down the settings, they can be easily re-entered by your service staff once any repairs have been completed.

Menu	Setting
<b>MODE OF OPERATION</b>	
Time-controlled	
Volume interval	
External (Start)	
<b>DISPLAY UNIT 1</b>	
Display in °dH	
Display in °f	
Display in ppm CaCO <sub>3</sub>	
Display in mmol/l	
<b>DISPLAY UNIT 2</b>	
Display in °dH	
Display in °f	
Display in ppm CaCO <sub>3</sub>	
Display in mmol/l	
<b>TYPE OF REAGENT 1</b>	
500ml-bottle	
100ml-bottle	
TH2005 Water hard.	
TH2025 Water hard.	
TH2100 Water hard.	
TH2250 Water hard.	
TC2050 Carbon. hardn.	
TC2100 Carbon. hardn.	
TM2005 minus-m-value	
TP2010 p-value	
TP2100 p-value	
<b>TYPE OF REAGENT 2</b>	
500ml-bottle	
100ml-bottle	
TH2005 Water hard.	
TH2025 Water hard.	
TH2100 Water hard.	
TH2250 Water hard.	
TC2050 Carbon. hardn.	
TC2100 Carbon. hardn.	
TM2005 minus-m-value	
TP2010 p-value	
TP2100 p-value	
<b>LIMIT VALUES</b>	
Limit val. 1:	
Limit val. 2:	
<b>FLUSH TIMES/INTERVAL</b>	
Internal flush time	
External flush time	
Interval pause	
<b>MEASURING POINTS</b>	
1 Measuring point	
2 Measuring points	
<b>TYPE OF WATER METER</b>	
1 Litre/Impulse	
2,5 Litres/Impulse	
5 Litres/Impulse	
10 Litres/Impulse	
100 Litres/Impulse	
500 Litres/Impulse	

1000 Litres/Impulse	
<b>PLANT CONTROL</b>	
Min. Res. Quant.	
Limit val. 1:	
Limit val. 2:	
<b>FUNCTION LV1</b>	
Duration	
Impulse	
Interval	
Time:	
<b>FUNCTION LV2</b>	
Duration	
Impulse	
Interval	
Time:	
<b>HYSTERESIS LV1</b>	
Analysis (1,2,3)	
<b>HYSTERESIS LV2</b>	
Analysis (1,2,3)	
<b>ALARM/MESSAGE</b>	
Reagent low level	
Low water pressure	
Mf. analysis	
Ff. optics	
Ff. dosing fault	
Ff. dosing pump	
Ff. outlet to drain	
Mf. dirtiness	
power failure 24 V	
Mf. turbid	
Meas. range exceeded	
Maint. int. exceeded	
<b>FUNCTION IN1</b>	
Normally open contact	
Normally closed contact	
<b>FUNCTION STOP</b>	
Normally open contact	
Normally closed contact	
<b>INTERFACES</b>	
Type 0-20 mA	
Type 4-20 mA	
Type RS232	
<b>FUNCTION AUX</b>	
Contact before analysis	
Contact during analysis	
Contact after analysis	
Time:	
<b>OPERATING TIME</b>	
<b>MAINTENANCE INTERV.</b>	
<b>CUSTOMER SERVICE</b>	

## Product overview Testomat 2000<sup>®</sup>-Instruments



Model/Type	Measuring Parameter	Measuring Range	Applications/Functions
<b>Testomat 2000<sup>®</sup></b>	<ul style="list-style-type: none"> <li>• Water hardness</li> <li>• Carbonate hardness</li> <li>• p-value</li> <li>• minus-m-value</li> </ul>	0.05-25 °dH 0,5-20 °dH 1-15 mmol/l 0.05-0.5 mmol/l	<ul style="list-style-type: none"> <li>• Universal for water treatment plants</li> <li>• allowed for boiler houses</li> </ul>
<b>Testomat 2000<sup>®</sup> Antox</b>	as Testomat 2000 <sup>®</sup>	as Testomat 2000 <sup>®</sup>	<ul style="list-style-type: none"> <li>• dosing a reducing agent</li> </ul>
<b>Testomat 2000<sup>®</sup> CAL</b>	as Testomat 2000 <sup>®</sup>	as Testomat 2000 <sup>®</sup>	<ul style="list-style-type: none"> <li>• Automatic calibration function</li> </ul>
<b>Testomat 2000<sup>®</sup> CLF</b>	<ul style="list-style-type: none"> <li>• Free Chlorine</li> </ul>	0-2.5 mg/l	<ul style="list-style-type: none"> <li>• DPD-method for swimming pool and drinking water control</li> </ul>
<b>Testomat 2000<sup>®</sup> CLT</b>	<ul style="list-style-type: none"> <li>• Total Chlorine</li> </ul>	0-2.5 mg/l	<ul style="list-style-type: none"> <li>• DPD-method for swimming pool and drinking water control</li> </ul>
<b>Testomat 2000<sup>®</sup> CrVI</b>	<ul style="list-style-type: none"> <li>• Chromate</li> <li>• Chrome-VI</li> </ul>	0-2.0 mg/l 0-1.0 mg/l	<ul style="list-style-type: none"> <li>• process control of waste water in galvanic industry</li> </ul>
<b>Testomat 2000<sup>®</sup> Duo</b>	as Testomat 2000 <sup>®</sup>	as Testomat 2000 <sup>®</sup>	<ul style="list-style-type: none"> <li>• Controlling of two measuring points</li> </ul>
<b>Testomat 2000<sup>®</sup> Fe</b>	<ul style="list-style-type: none"> <li>• Iron-II and Iron-III</li> </ul>	0-1.0 mg/l	<ul style="list-style-type: none"> <li>• De-Ironing plants</li> </ul>
<b>Testomat 2000<sup>®</sup> SO<sub>3</sub></b>	<ul style="list-style-type: none"> <li>• Sulphite</li> </ul>	0-20 mg/l	<ul style="list-style-type: none"> <li>• Control of the Oxygen-binding by Sulphite in boiler feed water</li> </ul>
<b>Testomat 2000<sup>®</sup> self clean</b>	as Testomat 2000 <sup>®</sup>	as Testomat 2000 <sup>®</sup>	<ul style="list-style-type: none"> <li>• Automatic cleaning of the measuring chamber</li> </ul>
<b>Testomat 2000 THCL<sup>®</sup></b>	<ul style="list-style-type: none"> <li>• Total Chlorine</li> <li>• Water hardness</li> </ul>	0-2.5 mg/l 0.25-2.5 °dH	<ul style="list-style-type: none"> <li>• DPD-method for swimming pool and drinking water control</li> <li>• combination system for hardness and chlorine</li> </ul>
<b>Testomat 2000<sup>®</sup> V</b>	<ul style="list-style-type: none"> <li>• Water hardness</li> <li>• Carbonate hardness</li> </ul>	1.0-25.0 °dH 1.0-20.0 °dH	<ul style="list-style-type: none"> <li>• blending water</li> </ul>

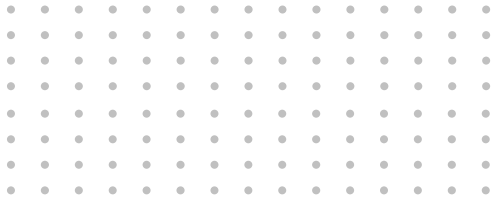

Gebrüder Heyl  
Analysentechnik GmbH & Co. KG  
Orleansstraße 75b  
D 31135 Hildesheim  
[www.heyhl.de](http://www.heyhl.de)

Testomat\_2000\_DUO\_GB\_190423



Scan the code and  
visit us on our website!